

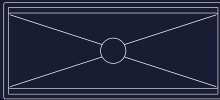

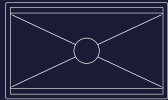

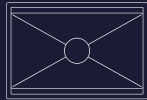

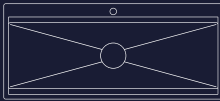

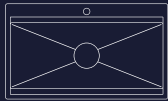
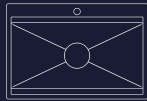
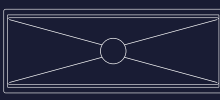

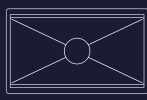
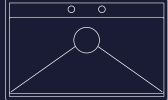
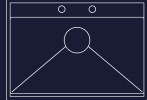

ARTINOX



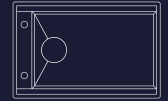
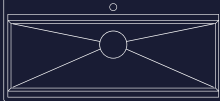
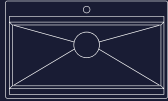
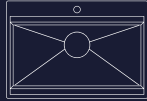
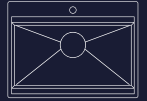

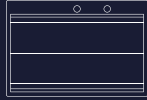
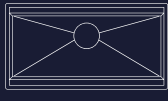
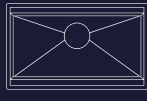















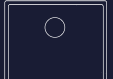







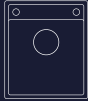
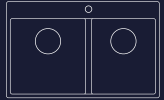
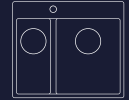





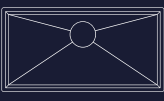
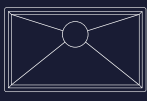

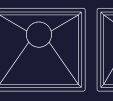



WORKSTATION SINKS

VISUAL INDEX

WORKSTATIONS

	120	90	80	75	60
PLANUM	 Pg. 21	 22	 23		
	 Pg. 27	 28	 29		
	 Pg. 31	 32	 33		
NEWGO		 39	 40	 41	
		 45	 46	 47	
LAYER	 Pg. 54	 55			
	 Pg. 59	 60	 61	 62	 63
		 66	 67		
	 70	 71	 72	 73	

SINKS

	90	80	75	60	45
TITANIUM		 79		 80	 81
		 83		 84	 85
		 87		 88	 89
RADIUS		 95		 96	 97
	 Pg. 101	 102	 103	 104	 105
				 106	 107
GHOST				 111	
MOSE	 Pg. 116	 117			
	 Pg. 118	 119			
AQUA	 Pg. 124	 125	 126	 127	
PRISMA	 Pg. 133	 134	 135	 136	 137
				 138	 139
LINEA		 144	 145	 146	 147
				 148	 149
SHORE		 154	 155	 156	 157
				 158	 159

WORKSTATION SINKS

HISTORY AND PASSION

Artinox was founded in 1985 by Mario Zanardo in Conegliano in one of the most important Italian industrial areas known for the stainless steel processing. Dedicated to the high-end kitchen market, all our collections are designed and produced with passion in our factory and distributed all over the world.



QUALITY AND SUSTAINABILITY

Beyond the intrinsic qualities of the raw material, we are committed to the implementation of our environmental management system. At Artinox we have been using the control of all processes to guarantee the maximum result of the services offered - ISO 9001 certification - and taking care of the factors interacting with the environment - ISO 14001 -.



WORKSTATION, THE INNOVATIVE DESIGN

At Artinox we revolutionize the time spent in the kitchen. All of the Workstations are integrated into the worktop becoming one. The sliding system allows the positioning and the sliding of infinite accessories dedicated to multiple functions; from grids to supports, from chopping boards to containers, these accessories are made to last and to serve with a simple gesture.



OUR STAINLESS STEEL

Our stainless steel it's used in both domestic and professional environments while meeting all industry standards. It's extremely easy to clean thanks to the non-porous surface, which results in a high antibacterial property. Our steel is unalterable over time, is made up of over 70% recycled materials and is 100% recyclable.





DETAILS THAT MAKE THE DIFFERENCE

Dedicated accessories

The stainless steel accessories, always thickly produced in our factories, are dishwasher safe.

The chopping boards are made of wood or non-toxic polyethylene.

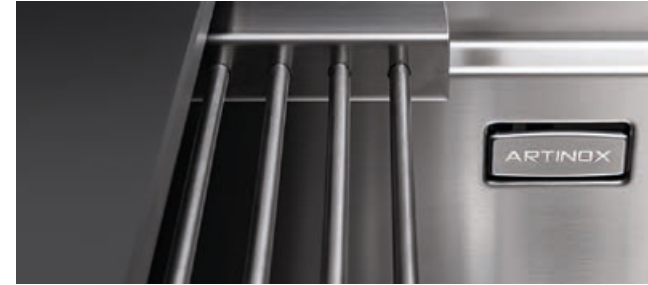

High thickness steel

We use AISI 304 stainless steel of increased thickness compared to normal market standards, guaranteeing robust products with a unique design.



Welded products

Artinox produces exclusively Kitchen systems with welding process, 10mm radius corner or zero/45 radius corners.

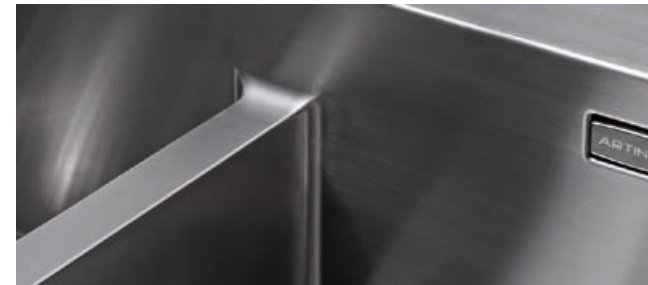

Generous sizes

Collections are available in various sizes from 170 to 250 depth. Large capacity and functionality.



Holes

All the models in our collections are set up with one or two 35 mm diameter holes for housing the mixer. Additional holes can be requested.



Pop-up kit

The practical push pop-up kits, combined with the drains system, avoid getting your hands wet in emptying the sink. These are products from selected Italian partners.



Overflowing system

All products have an integrated back wall overflow and are designed without joints to ensure maximum hygiene.



Drainage enhanced bottoms

The outflow of the water is guaranteed also by an invitation near the drain and, in specific collections, also by elegant diamond-finished basin bottoms.



3 1/2" Drains

The exclusive drains of our models are produced by selected Italian partners. All models, variants and colors are always in stainless steel.



Space-saving 'U'-trap

The space-saving self-cleaning 'u' trap solutions are available for all our collections. The small size and easy adjustability increase the space under the sink.

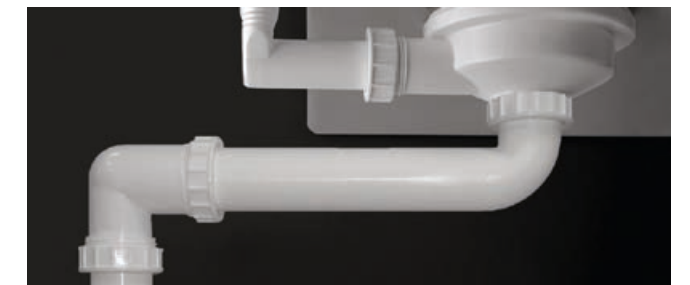

A SET-UP FOR EVERY STYLE

Over-mount

The over-mount option always allows easy installation on tops of any material.



Flush-mount

The visible perimeter of the Flush-mount evokes cleanliness, the edge is perfectly rectified with a two tenths of a millimeter tolerance.



Under-mount

The Under-mount solution allows you to make the most out of the surface of the kitchen countertop.

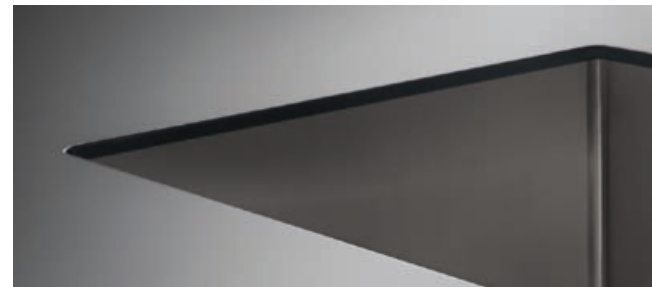

Edgeless

The Edgeless installation allows worktop edges to join maximizing the combination between hygiene and aesthetics.

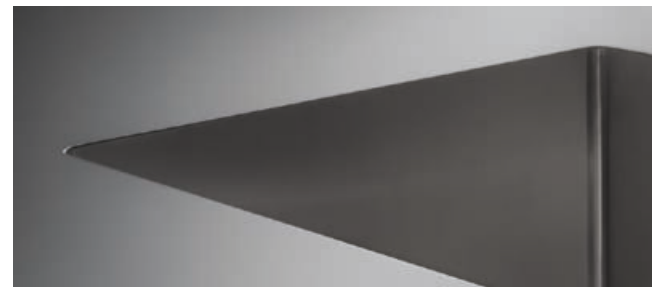

Integrated

Innovative installation between stainless steel bottom vertically glued and the kitchen countertop.



INDEX

WORKSTATIONS

PLANUM	18
NEWGO	36
LAYER	50

SINKS

TITANIUM	76
RADIUS	92
GHOST	110
MOSE	114
AQUA	122
PRISMA	130
LINEA	142
SHORE	152

SINK MIXERS	162
-------------	-----

COMPLEMENTS	170
-------------	-----

CLEANING PRODUCTS	172
-------------------	-----

BUSINESS CONDITIONS	174
---------------------	-----

PLANUM



PLANUM XL

With this stainless steel workstation of generous dimensions you can really enjoy your time in the kitchen. Thanks to the sliding system a huge number of accessories with different functions can be used: grids, trays, chopping boards and basins made to last and serve in one unique gesture.



PLANUM XL 111

READY

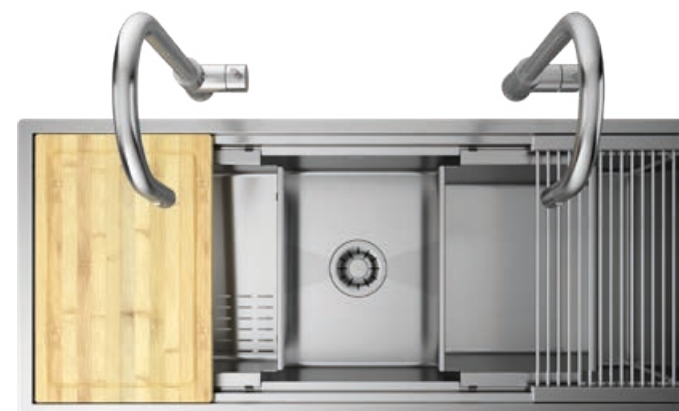

- Wooden chopping board 1
- Slanted colander 23
- Basin 26
- Grid 10
- Loft Tap 38
- Loft Tap 38

Top mount

Cod. **SAP I 11**

PLANUM XL 111

PRO



- Wooden chopping board 1
- Slanted colander 23

Top mount

Cod. **SBP I 11**

PLANUM XL 111

SOLO



- Material AISI 304
- Finishing Brushed
- Inner Corner R 10 mm Welded
- Overall dimensions 1160 × 510 mm
- Basin dimensions 1110 × 400 mm
- Bowl depth 254 mm
- Plus Strainer 3 ½"
- Cabinet size 1200 mm

Top mount

Cod. **PI 11 4025**

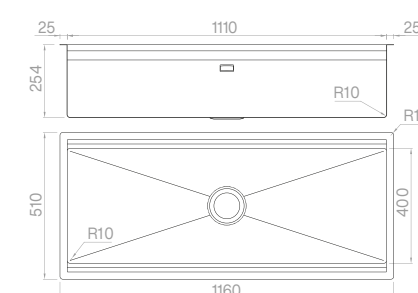

Accessories



See p. 25 for all dedicated accessories.

PLANUM XL 81 **READY**

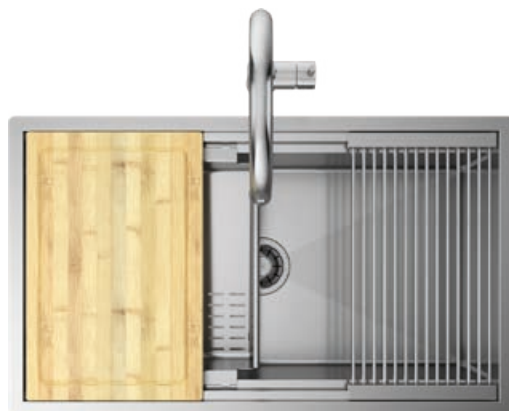

- Wooden chopping board
- Slanted colander
- Grid
- Loft Tap

- 1
- 23
- 10
- 38

Top mount

Cod. **SAP I 81**

PLANUM XL 81 **PRO**



- Wooden chopping board
- Slanted colander

- 1
- 23

Top mount

Cod. **SBP I 81**

PLANUM XL 81 **SOLO**



- | | |
|--------------------|----------------|
| Material | AISI 304 |
| Finishing | Brushed |
| Inner Corner | R 10 mm Welded |
| Overall dimensions | 860 × 510 mm |
| Basin dimensions | 810 × 400 mm |
| Bowl depth | 254 mm |
| Plus Strainer | 3 ½" |
| Cabinet size | 900 mm |

Top mount

Cod. **PI 81 4025**

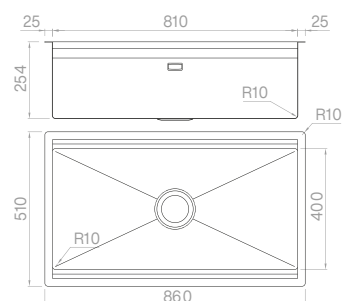

Accessories



See p. 25 for all dedicated accessories.

PLANUM XL 70 **READY**

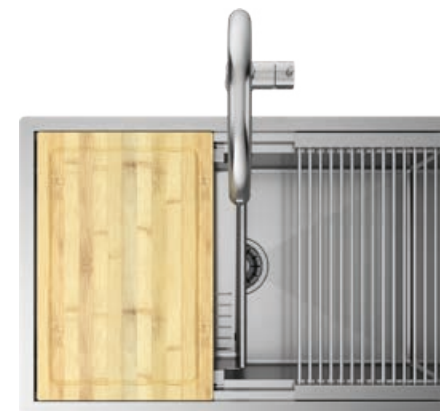

- Wooden chopping board
- Slanted colander
- Grid
- Loft Tap

- 1
- 23
- 10
- 38

Top mount

Cod. **SAP I 70**

PLANUM XL 70 **PRO**



- Wooden chopping board
- Slanted colander

- 1
- 23

Top mount

Cod. **SBP I 70**

PLANUM XL 70 **SOLO**



- | | |
|--------------------|----------------|
| Material | AISI 304 |
| Finishing | Brushed |
| Inner Corner | R 10 mm Welded |
| Overall dimensions | 750 × 510 mm |
| Basin dimensions | 700 × 400 mm |
| Bowl depth | 254 mm |
| Plus Strainer | 3 ½" |
| Cabinet size | 800 mm |

Top mount

Cod. **PI 70 4025**

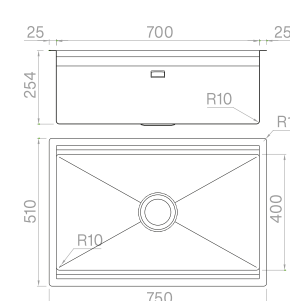

Accessories



See p. 25 for all dedicated accessories.

Wooden chopping board

1

300×457×20 mm
Cod. **TRIB 3045****HDPE chopping board**

6

240×420×20 mm
Cod. **TRP 2442****Bottle holder set**

7

130×457×170 mm
Cod. **VPB 3C****Drainer**

8

250×457×15 mm
Cod. **VPB 2545****Grid**

10

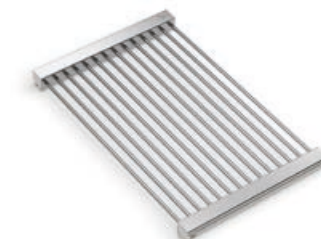
300×457×25 mm
Cod. **GRS 3045****Colander**

16

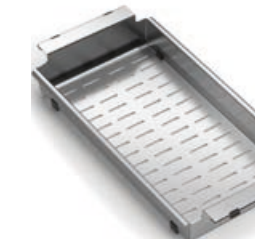
210×420×60 mm
Cod. **VQSF 2142****Slanted colander**

23

280×420×110/60 mm
Cod. **VQSI 2842****Basin**

26

280×420×160 mm
Cod. **VQSP 2842****Gastronorm set**

30

240×420×100 mm
Cod. **TI 2442 V****Strainer set**

32

240×420×100 mm
Cod. **TI 2442 1S****Slicer/grater set**

34

200×420×20 mm
Cod. **TI 2442 PG****Dish holder**

36

250×420×55 mm
Cod. **PPPB V400**

PLANUM BR

All Planum workstations offer a double slide level. Thanks to the many accessory combinations you can customize your working area.



PLANUM BR 111

READY



- Wooden chopping board **2**
- Slanted colander **25**
- Basin **27**
- Grid **11**
- Loft Tap **38**

Top mount

Cod. **SAP BRI 11**

PLANUM BR 111

PRO



- Wooden chopping board **2**
- Slanted colander **25**

Top mount

Cod. **SBP BRI 11**

PLANUM BR 111

SOLO



- Material AISI 304
- Finishing Brushed
- Inner Corner R 10 mm Welded
- Overall dimensions 1160 × 505 mm
- Basin dimensions 1110 × 350 mm
- Bowl depth 224 mm
- Plus Strainer 3 1/2"
- Cabinet size 1200 mm

Top mount

Cod. **ALP BRI 11**

Mixer hole: specify extra holes when ordering.

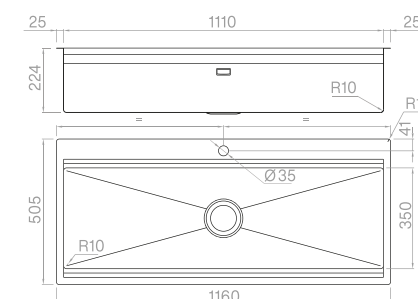

Accessories



See p. 35 for all dedicated accessories.

PLANUM BR 81 **READY**

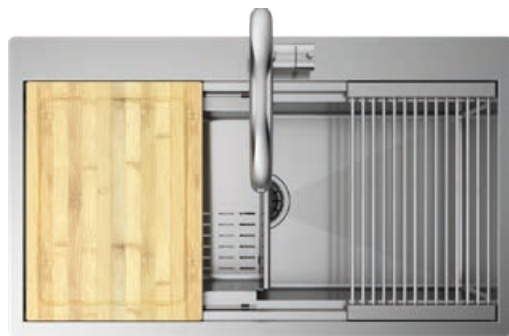

- Wooden chopping board **2**
- Slanted colander **25**
- Grid **11**
- Loft Tap **38**

Top mount Cod. **SAP BRI 81**

PLANUM BR 70 **READY**

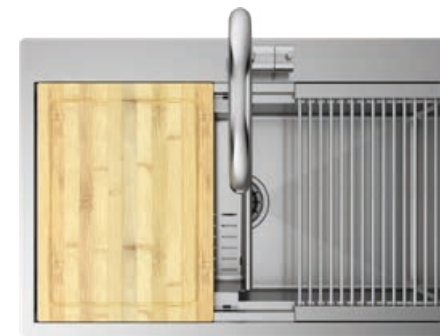

- Wooden chopping board **2**
- Slanted colander **25**
- Grid **11**
- Loft Tap **38**

Top mount Cod. **SAP BRI 70**

PLANUM BR 81 **PRO**



- Wooden chopping board **2**
- Slanted colander **25**

Top mount Cod. **SBP BRI 81**

PLANUM BR 70 **PRO**



- Wooden chopping board **2**
- Slanted colander **25**

Top mount Cod. **SBP BRI 70**

PLANUM BR 81 **SOLO**



Material	AISI 304
Finishing	Brushed
Inner Corner	R 10 mm Welded
Overall dimensions	860 × 505 mm
Basin dimensions	810 × 350 mm
Bowl depth	224 mm
Plus Strainer	3 ½"
Cabinet size	900 mm

Top mount Cod. **ALP BRI 81**

PLANUM BR 70 **SOLO**



Material	AISI 304
Finishing	Brushed
Inner Corner	R 10 mm Welded
Overall dimensions	750 × 505 mm
Basin dimensions	700 × 350 mm
Bowl depth	224 mm
Plus Strainer	3 ½"
Cabinet size	800 mm

Top mount Cod. **ALP BRI 70**

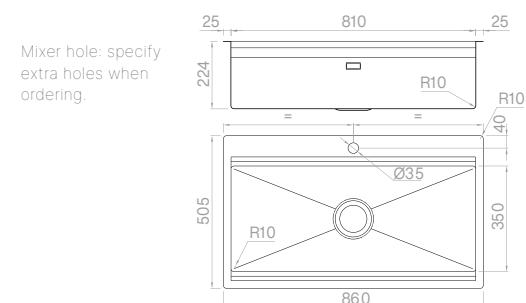

Mixer hole: specify extra holes when ordering.

Accessories



See p. 35 for all dedicated accessories.

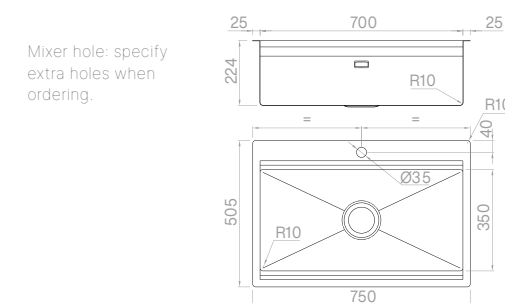

Mixer hole: specify extra holes when ordering.

Accessories



See p. 35 for all dedicated accessories.

PLANUM ST

The Planum collections are functional even in small spaces. With the u/m installing you can use the whole working area at its best.



PLANUM ST 111

READY



- Wooden chopping board **2**
- Slanted colander **25**
- Basin **27**
- Grid **11**
- Loft Tap **38**

 Under mount **Cod. SAPO 11 L1**

PLANUM ST 111

PRO



- Wooden chopping board **2**
- Slanted colander **25**

 Under mount **Cod. SBPO 11 L1**

PLANUM ST 111

SOLO



- Material AISI 304
- Finishing Brushed
- Inner Corner R 10 mm Welded
- Overall dimensions 1150 × 440 mm
- Basin dimensions 1110 × 350 mm
- Bowl depth 204 mm
- Plus Strainer 3 1/2"
- Cabinet size 1200 mm

 Under mount **Cod. PO 11 L1**

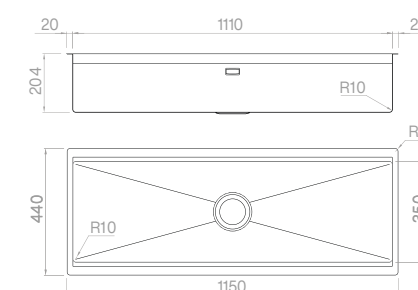

Accessories



See p. 35 for all dedicated accessories.

PLANUM ST 81 **READY**

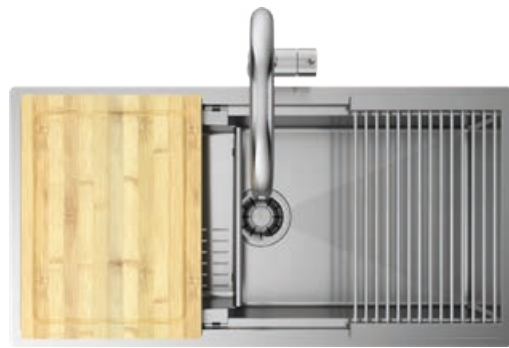

- Wooden chopping board
- Slanted colander
- Grid
- Loft Tap

- 2
- 25
- 11
- 38

Under mount Cod. **SAPO 81 L1**

PLANUM ST 81 **PRO**



- Wooden chopping board
- Slanted colander

- 2
- 25

Under mount Cod. **SBPO 81 L1**

PLANUM ST 81 **SOLO**



Material	AISI 304
Finishing	Brushed
Inner Corner	R 10 mm Welded
Overall dimensions	850 × 440 mm
Basin dimensions	810 × 350 mm
Bowl depth	204 mm
Plus Strainer	3 ½"
Cabinet size	900 mm

Under mount Cod. **PO 81 L1**

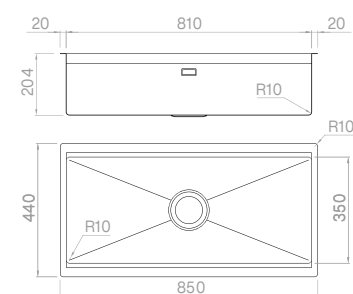

Accessories

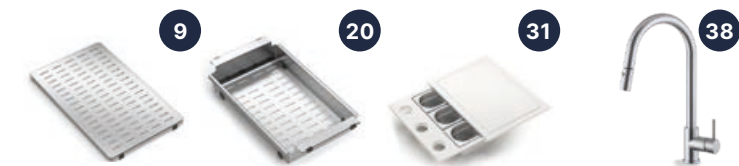

See p. 35 for all dedicated accessories.

PLANUM ST 70 **READY**

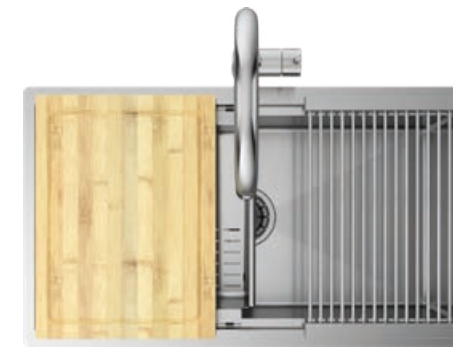

- Wooden chopping board
- Slanted colander
- Grid
- Loft Tap

- 2
- 25
- 11
- 38

Under mount Cod. **SAPO 70 L1**

PLANUM ST 70 **PRO**



- Wooden chopping board
- Slanted colander

- 2
- 25

Under mount Cod. **SBPO 70 L1**

PLANUM ST 70 **SOLO**



Material	AISI 304
Finishing	Brushed
Inner Corner	R 10 mm Welded
Overall dimensions	740 × 440 mm
Basin dimensions	700 × 350 mm
Bowl depth	204 mm
Plus Strainer	3 ½"
Cabinet size	800 mm

Under mount Cod. **PO 70 L1**

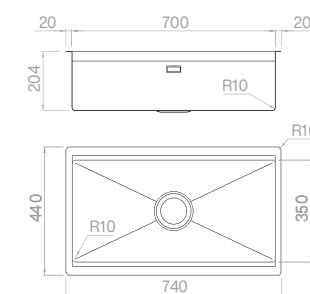

Accessories



See p. 35 for all dedicated accessories.



Wooden chopping board 2

300×407×20 mm
Cod. **TRIB 3041**



Drainer 9

250×407×15 mm
Cod. **VPB 2541**

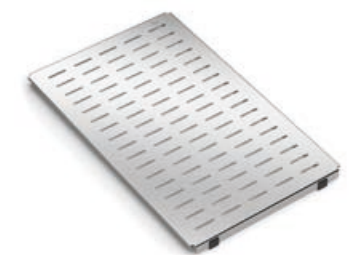

Grid 11

300×407×25 mm
Cod. **GRS 3041**



Colander 20

210×375×60 mm
Cod. **VQSF 2137**



Slanted colander 25

280×370×110/60 mm
Cod. **VQSI 2837**



Basin 27

280×370×140 mm
Cod. **VQSP 2837**



Chopping board + gastronorm set 31

300×405×100 mm
Cod. **TPLB 3V**



Chopping board + pasta strainer set 33

300×405×100 mm
Cod. **TPLB 1S**



Chopping board + knife holder frame set 35

300×405×20 mm
Cod. **TPLB 4030**





NEWGO MATTE VINTAGE

An elegant and sophisticated workstation which combines the matte vintage stainless steel finishing with the black finishing of the mixers and accessories.



NEWGO 81 MATTE VINTAGE

READY



Grid matte vintage
Slanted colander matte vintage
Ergo Tap

13
24
41

Top mount
Flush mount

Cod. **SAG I 81H**
Cod. **SAGG 81H**

NEWGO 81 MATTE VINTAGE

PRO



Grid matte vintage

13

Top mount
Flush mount

Cod. **SBG I 81H**
Cod. **SBGG 81H**

NEWGO 81 MATTE VINTAGE

SOLO



Material	AISI 304
Finishing	Brushed matte
Inner Corner	R 10 mm Welded
Overall dimensions	850 × 530 mm
Basin dimensions	810 × 400 mm
Bowl depth	220 mm
Automatic black pop-up drain system	3 ½"
Cabinet size	900 mm

Top mount
Flush mount

Cod. **ALG I 81H**
Cod. **ALGG 81H**

Mixer hole: specify extra holes when ordering.

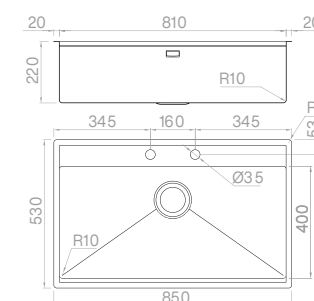

Accessories



See p. 43 for all dedicated accessories.

NEWGO 70 MATTE VINTAGE

READY

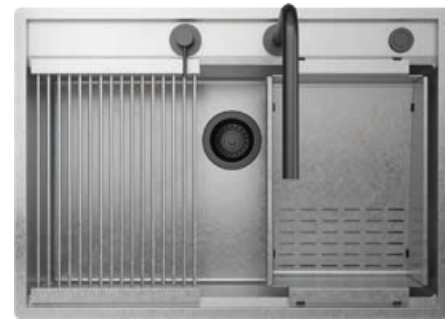

- Grid matte vintage
- Slanted colander matte vintage
- Ergo Tap

13
24
41

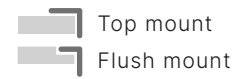

Cod. **SAG I 70H**
Cod. **SAGG 70H**

NEWGO 70 MATTE VINTAGE

PRO

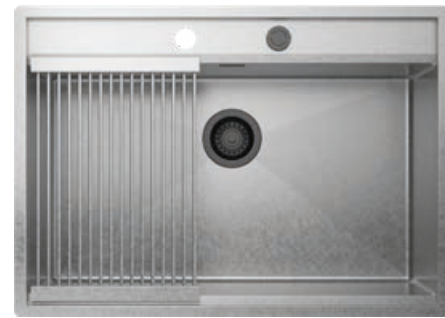

- Grid matte vintage

13

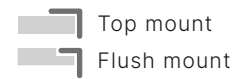

Cod. **SBG I 70H**
Cod. **SBGG 70H**

NEWGO 70 MATTE VINTAGE

SOLO



Material	AISI 304
Finishing	Brushed matte
Inner Corner	R 10 mm Welded
Overall dimensions	740 × 530 mm
Basin dimensions	700 × 400 mm
Bowl depth	220 mm
Automatic black pop-up drain system	3 ½"
Cabinet size	800 mm

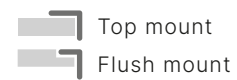

Cod. **ALG I 70H**
Cod. **ALGG 70H**

Mixer hole: specify extra holes when ordering.

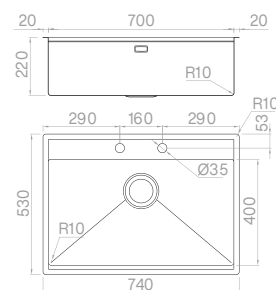

Accessories



See p. 43 for all dedicated accessories.

NEWGO 65 MATTE VINTAGE

READY

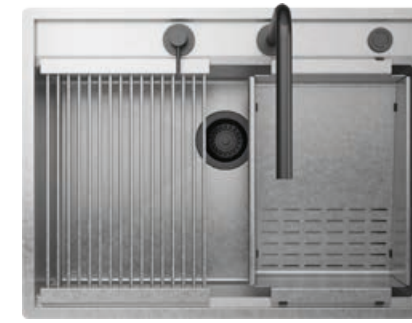

- Grid matte vintage
- Slanted colander matte vintage
- Ergo Tap

13
24
41



Cod. **SAG I 65H**
Cod. **SAGG 65H**

NEWGO 65 MATTE VINTAGE

PRO

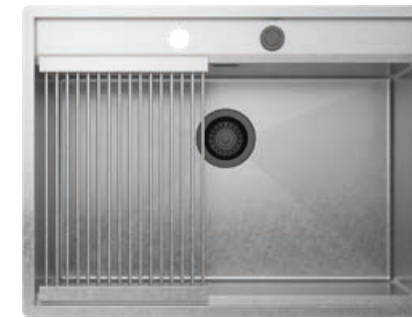

- Grid matte vintage

13

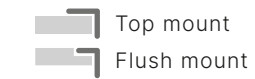

Cod. **SBG I 65H**
Cod. **SBGG 65H**

NEWGO 65 MATTE VINTAGE

SOLO



Material	AISI 304
Finishing	Brushed matte
Inner Corner	R 10 mm Welded
Overall dimensions	690 × 530 mm
Basin dimensions	650 × 400 mm
Bowl depth	220 mm
Automatic black pop-up drain system	3 ½"
Cabinet size	750 mm



Cod. **ALG I 65H**
Cod. **ALGG 65H**

Mixer hole: specify extra holes when ordering.

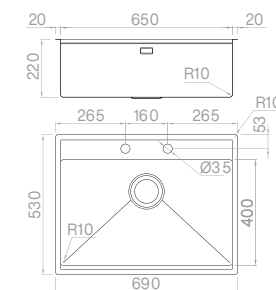

Accessories

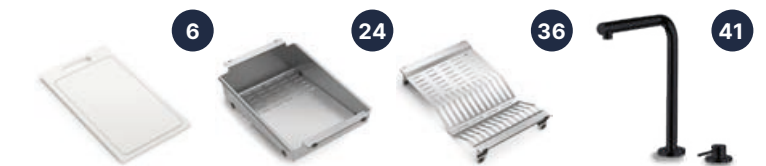

See p. 43 for all dedicated accessories.

Wooden chopping board

3

300×420×20 mm
Cod. **TRIB 3042**



HDPE chopping board

6

240×420×20 mm
Cod. **TRP 2442**



Grid matte vintage

13

250×420×25 mm
Cod. **GRH 2542**



Slanted colander matte vintage

24

280×420×110/60 mm
Cod. **VQHI 2842**



Gastronorm set

30

240×420×100 mm
Cod. **TI 2442 V**



Colander set

32

240×420×100 mm
Cod. **TI 2442 1S**



Slicer/grater set

34

200×420×20 mm
Cod. **TI 2442 PG**



Dish holder

36

250×420×55 mm
Cod. **PPPB V400**



NEWGO

The bigger depth and the perimeter lowering allow to house the mixer inside the working area.



NEWGO 81

READY

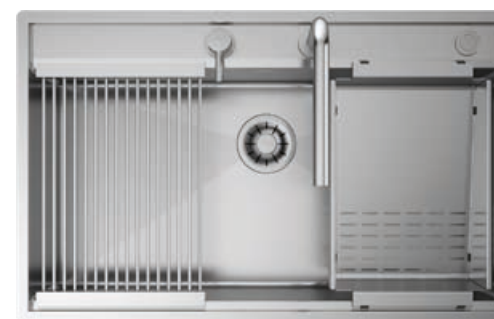

- Grid 12
- Slanted colander 23
- Circle Tap 45

- Top mount Cod. **SAG I 81**
- Flush mount Cod. **SAGG 81**

NEWGO 81

PRO

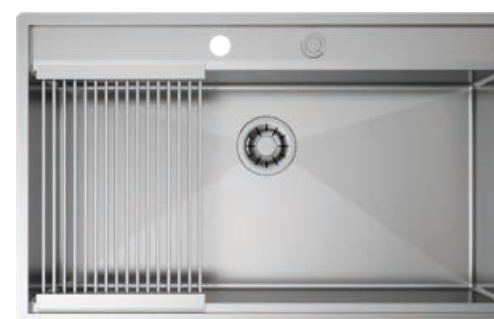

- Grid 12

- Top mount Cod. **SBG I 81**
- Flush mount Cod. **SBGG 81**

NEWGO 81

SOLO



- Material AISI 304
- Finishing Brushed
- Inner Corner R 10 mm Welded
- Overall dimensions 850 × 530 mm
- Basin dimensions 810 × 400 mm
- Bowl depth 220 mm
- Automatic pop-up drain system 3 1/2"
- Cabinet size 900 mm

- Top mount Cod. **ALG I 81**
- Flush mount Cod. **ALGG 81**

Mixer hole: specify extra holes when ordering.

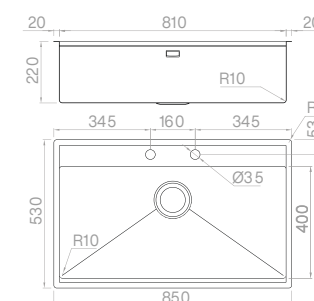

Accessories

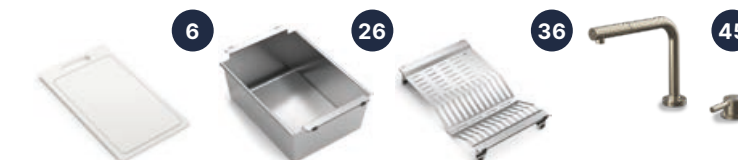

See p. 49 for all dedicated accessories.

NEWGO 70

READY



- Grid **12**
- Slanted colander **23**
- Circle Tap **45**

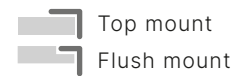

Cod. **SAG I 70**
Cod. **SAGG 70**

NEWGO 70

PRO



- Grid **12**

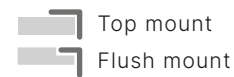

Cod. **SBG I 70**
Cod. **SBGG 70**

NEWGO 70

SOLO



Material	AISI 304
Finishing	Brushed
Inner Corner	R 10 mm Welded
Overall dimensions	740 × 530 mm
Basin dimensions	700 × 400 mm
Bowl depth	220 mm
Automatic pop-up drain system	3 ½"
Cabinet size	800 mm

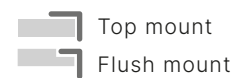

Cod. **ALG I 70**
Cod. **ALGG 70**

Mixer hole: specify extra holes when ordering.

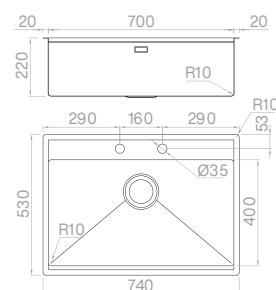

Accessories

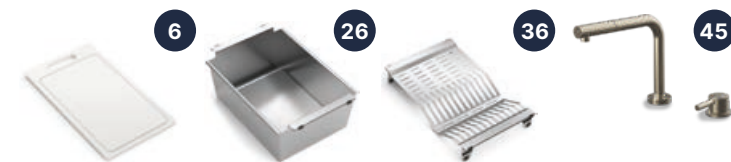

See p. 49 for all dedicated accessories.

NEWGO 65

READY



- Grid **12**
- Slanted colander **23**
- Circle Tap **45**



Cod. **SAG I 65**
Cod. **SAGG 65**

NEWGO 65

PRO

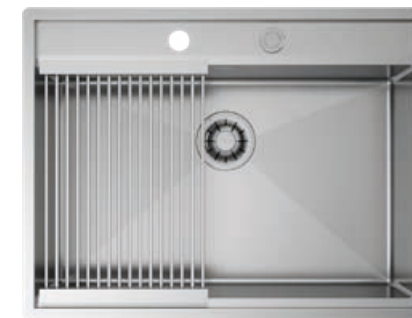

- Grid **12**



Cod. **SBG I 65**
Cod. **SBGG 65**

NEWGO 65

SOLO



Material	AISI 304
Finishing	Brushed
Inner Corner	R 10 mm Welded
Overall dimensions	690 × 530 mm
Basin dimensions	650 × 400 mm
Bowl depth	220 mm
Automatic pop-up drain system	3 ½"
Cabinet size	750 mm

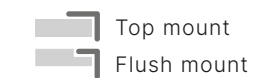

Cod. **ALG I 65**
Cod. **ALGG 65**

Mixer hole: specify extra holes when ordering.

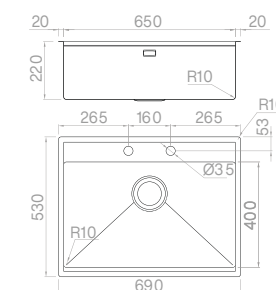

Accessories

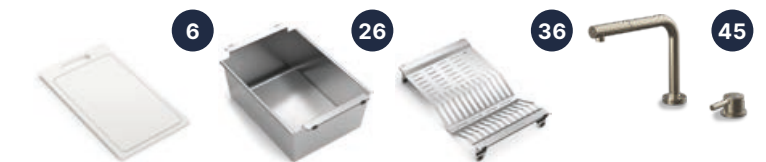

See p. 49 for all dedicated accessories.

Wooden chopping board**3**300×420×20 mm
Cod. **TRIB 3042****HDPE chopping board****6**240×420×20 mm
Cod. **TRP 2442****Grid****12**250×420×25 mm
Cod. **GRS 2542****Set Colander****16**210×420×60 mm
Cod. **VQSF 2142****Slanted colander****23**280×420×110/60 mm
Cod. **VQSI 2842****Basin****26**280×420×160 mm
Cod. **VQSP 2842****Gastronorm set****30**240×420×100 mm
Cod. **TI 2442 V****Strainer set****32**240×420×100 mm
Cod. **TI 2442 1S****Slicer/grater set****34**200×420×20 mm
Cod. **TI 2442 PG****Dish holder****36**250×420×55 mm
Cod. **PPPB V400**

LAYER



LAYER BRL

An essential and functional aesthetics thanks to the wide depth which improves the capacity.
Everything is kept inside the sink and each accessory perfectly slides aligned with the worktop.



LAYER BRL 104 **READY**



- Wooden chopping board
- Colander
- Grid
- Element Tap

4
48
14
40

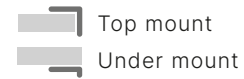

Cod. **SA BRL I 10**
Cod. **SA BRLO 10**

LAYER BRL 74 **READY**



- Wooden chopping board
- Colander
- Element Tap

4
48
40



Cod. **SA BRL I 74**
Cod. **SA BRLO 74**

LAYER BRL 104 **PRO**



- Wooden chopping board
- Colander

4
48

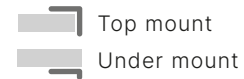

Cod. **SB BRL I 10**
Cod. **SB BRLO 10**

LAYER BRL 74 **PRO**



- Wooden chopping board

4



Cod. **SB BRL I 74**
Cod. **SB BRLO 74**

LAYER BRL 104 **SOLO**



Material	AISI 304
Finishing	Brushed
Inner Corner	'0' Radius angle
Overall dimensions	1080 × 510 mm
Basin dimensions	960 × 410 mm
Bowl depth	230 mm
Plus Strainer	3 ½"
Cabinet size	1200 mm

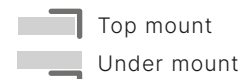

Cod. **AL BRL I 10**
Cod. **AL BRLO 10**

LAYER BRL 74 **SOLO**



Material	AISI 304
Finishing	Brushed
Inner Corner	'0' Radius angle
Overall dimensions	780 × 510 mm
Basin dimensions	660 × 410 mm
Bowl depth	230 mm
Plus Strainer	3 ½"
Cabinet size	900 mm

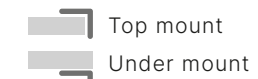

Cod. **AL BRL I 74**
Cod. **AL BRLO 74**

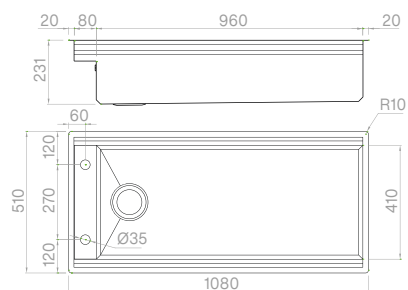

Accessories

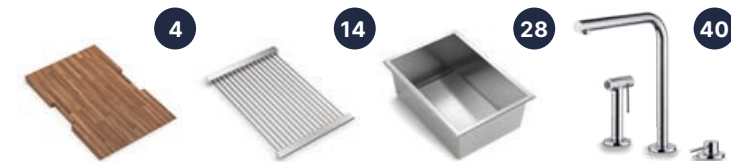

See p. 57 for all dedicated accessories.

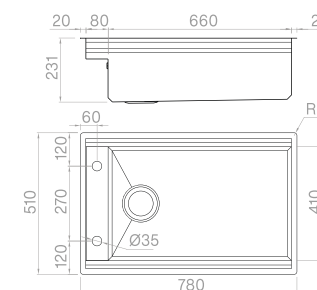

Accessories

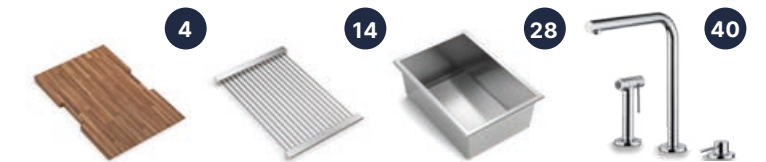

See p. 57 for all dedicated accessories.

Wooden chopping board**4**345×465×25 mm
Cod. **TBRL 4634****Grid****14**300×465×25 mm
Cod. **GFL 4630****Colander****21**190×435×80 mm
Cod. **VFPB RL19****Basin****28**345×435×160 mm
Cod. **VGB RL34****Colander****48**345×435×80 mm
Cod. **VFGB RL34**

LAYER BRP

An exclusive design with a system of inclined reservoirs where all accessories slide on two levels. On the first level chopping boards and racks slide, on the second level we find basins and colanders.



LAYER BRP 104

READY



- Wooden chopping board
- Colander
- Grid
- Element Tap

- 5
- 49
- 15
- 40

Top mount

Cod. **SA BRP 104**

LAYER BRP 104

PRO



- Wooden chopping board
- Colander

- 5
- 49

Top mount

Cod. **SB BRP 104**

LAYER BRP 104

SOLO



- Material AISI 304
- Finishing Brushed
- Inner Corner '0' Radius angle
- Overall dimensions 1080 × 510 mm
- Basin dimensions 1040 × 350 mm
- Bowl depth 210 mm
- Plus Strainer 3 1/2"
- Cabinet size 1200 mm

Top mount

Cod. **AL BRP 104**

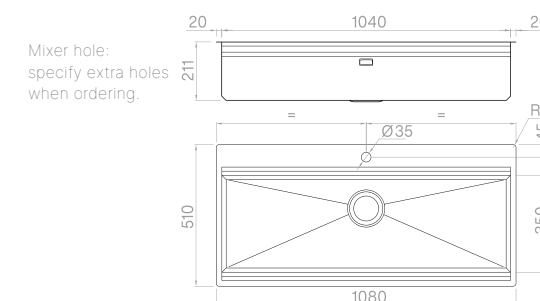

Accessories



See p. 75 for all dedicated accessories.

LAYER BRP 81 **READY**



- Wooden chopping board
- Colander
- Grid
- Vertigo Tap

- 5
- 49
- 15
- 47

Top mount Cod. **SA BRP 81**

LAYER BRP 70 **READY**



- Wooden chopping board
- Colander
- Grid
- Vertigo Tap

- 5
- 22
- 15
- 47

Top mount Cod. **SA BRP 70**

LAYER BRP 81 **PRO**



- Wooden chopping board
- Colander

- 5
- 49

Top mount Cod. **SB BRP 81**

LAYER BRP 70 **PRO**



- Wooden chopping board
- Colander

- 5
- 22

Top mount Cod. **SB BRP 70**

LAYER BRP 81 **SOLO**



- | | |
|--------------------|------------------|
| Material | AISI 304 |
| Finishing | Brushed |
| Inner Corner | '0' Radius angle |
| Overall dimensions | 860 × 510 mm |
| Basin dimensions | 810 × 350 mm |
| Bowl depth | 210 mm |
| Plus Strainer | 3 ½" |
| Cabinet size | 900 mm |

Top mount Cod. **AL BRP 81**

LAYER BRP 70 **SOLO**



- | | |
|--------------------|------------------|
| Material | AISI 304 |
| Finishing | Brushed |
| Inner Corner | '0' Radius angle |
| Overall dimensions | 740 × 510 mm |
| Basin dimensions | 700 × 350 mm |
| Bowl depth | 210 mm |
| Plus Strainer | 3 ½" |
| Cabinet size | 800 mm |

Top mount Cod. **AL BRP 70**

Mixer hole: specify extra holes when ordering.

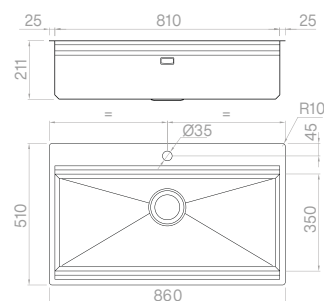

Accessories

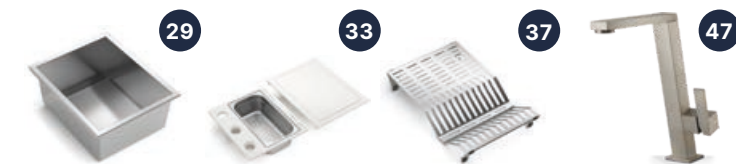

See p. 75 for all dedicated accessories.

Mixer hole: specify extra holes when ordering.

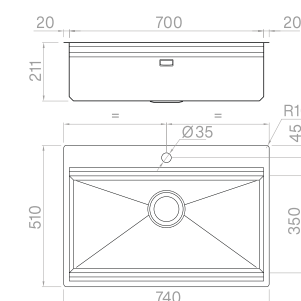

Accessories



See p. 75 for all dedicated accessories.

LAYER BRP 65 **READY**



Wooden chopping board
Colander
Vertigo Tap

5
22
47



Cod. **SA BRP 65**

LAYER BRP 65 **PRO**



Wooden chopping board

5



Cod. **SB BRP 65**

LAYER BRP 65 **SOLO**



Material	AISI 304
Finishing	Brushed
Inner Corner	'0' Radius angle
Overall dimensions	690 × 510 mm
Basin dimensions	650 × 350 mm
Bowl depth	210 mm
Plus Strainer	3 ½"
Cabinet size	750 mm



Cod. **AL BRP 65**

Mixer hole: specify extra holes when ordering.

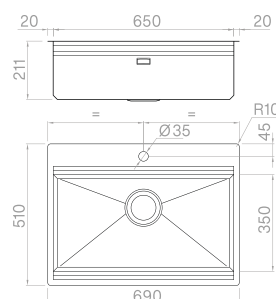

Accessories

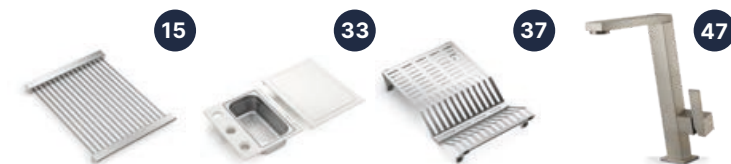

See p. 75 for all dedicated accessories.

LAYER BRP 50 **READY**



Wooden chopping board
Colander
Vertigo Tap

5
22
47



Cod. **SA BRP 50**

LAYER BRP 50 **PRO**



Wooden chopping board

5



Cod. **SB BRP 50**

LAYER BRP 50 **SOLO**



Material	AISI 304
Finishing	Brushed
Inner Corner	'0' Radius angle
Overall dimensions	540 × 510 mm
Basin dimensions	500 × 350 mm
Bowl depth	210 mm
Plus Strainer	3 ½"
Cabinet size	600 mm



Cod. **AL BRP 50**

Mixer hole: specify extra holes when ordering.

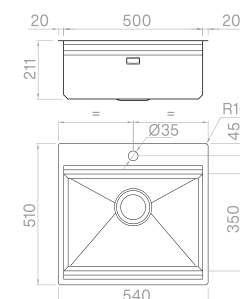

Accessories



See p. 75 for all dedicated accessories.

LAYER SP



An exclusive design, Layer SP is characterized by pure lines, it offers a small opening on the bottom which conceals the drain.

LAYER SP 81 READY



- Wooden chopping board
- Colander
- Grid
- Hero Tap

- 5
- 49
- 15
- 39

Top mount

Cod. SA BR81 SP

LAYER SP 70 READY



- Wooden chopping board
- Colander
- Grid
- Hero Tap

- 5
- 22
- 15
- 39

Top mount

Cod. SA BR70 SP

LAYER SP 81 PRO



- Wooden chopping board
- Colander

- 5
- 49

Top mount

Cod. SB BR81 SP

LAYER SP 70 PRO



- Wooden chopping board
- Colander

- 5
- 22

Top mount

Cod. SB BR70 SP

LAYER SP 81 SOLO



Material	AISI 304
Finishing	Brushed
Inner Corner	'0' Radius angle
Overall dimensions	860 × 510 mm
Basin dimensions	810 × 350 mm
Bowl depth	240 mm
Automatic pop-up drain system	3 1/2"
Cabinet size	900 mm

Top mount

Cod. AL BR81 SP

LAYER SP 70 SOLO



Material	AISI 304
Finishing	Brushed
Inner Corner	'0' Radius angle
Overall dimensions	740 × 510 mm
Basin dimensions	700 × 350 mm
Bowl depth	240 mm
Automatic pop-up drain system	3 1/2"
Cabinet size	800 mm

Top mount

Cod. AL BR70 SP

Mixer hole: specify extra holes when ordering.

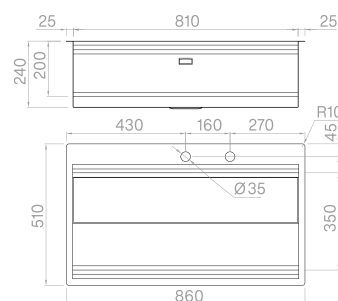

Accessories



See p. 75 for all dedicated accessories.

Mixer hole: specify extra holes when ordering.

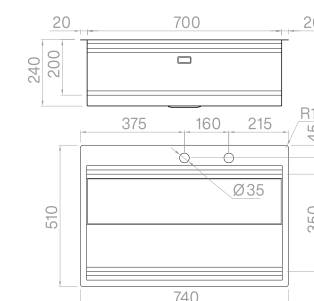

Accessories

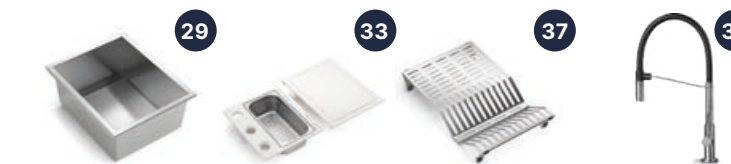

See p. 75 for all dedicated accessories.

LAYER SBR

An icone workstation thanks to chopping boards, trays and a lot of special accessories which allow you to customize your working area with endless possibilities.



LAYER SBR 104

READY



- Wooden chopping board
- Colander
- Grid
- Element Tap

- 5
- 49
- 15
- 40

- Top mount
- Under mount

Cod. **SA SBR 104**
Cod. **SA SBR ST1**

LAYER SBR 104

PRO



- Wooden chopping board
- Colander

- 5
- 49

- Top mount
- Under mount

Cod. **SB SBR 104**
Cod. **SB SBR ST1**

LAYER SBR 104

SOLO



- Material: AISI 304
- Finishing: Brushed
- Inner Corner: '0' Radius angle
- Overall dimensions: 1080 × 450 mm
- Basin dimensions: 1040 × 350 mm
- Bowl depth: 210 mm
- Plus Strainer: 3 1/2"
- Cabinet size: 1200 mm

- Top mount
- Under mount

Cod. **SBR 104**
Cod. **SBR ST 104**

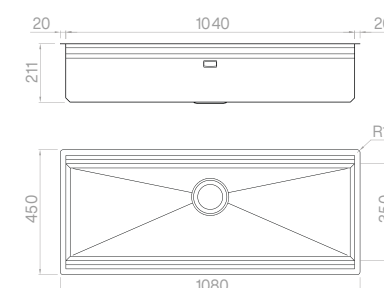



Accessories



See p. 75 for all dedicated accessories.



LAYER SBR 81 **READY**



- Wooden chopping board **5**
 - Colander **49**
 - Grid **15**
 - Vertigo Tap **47**
-  Top mount
 Under mount
- Cod. **SA SBR 81**
 Cod. **SA SBR ST8**



LAYER SBR 70 **READY**



- Wooden chopping board **5**
 - Colander **22**
 - Grid **15**
 - Vertigo Tap **47**
-  Top mount
 Under mount
- Cod. **SA SBR 70**
 Cod. **SA SBR ST7**



LAYER SBR 81 **PRO**



- Wooden chopping board **5**
 - Colander **49**
-  Top mount
 Under mount
- Cod. **SB SBR 81**
 Cod. **SB SBR ST8**



LAYER SBR 70 **PRO**



- Wooden chopping board **5**
 - Colander **22**
-  Top mount
 Under mount
- Cod. **SB SBR 70**
 Cod. **SB SBR ST7**



LAYER SBR 81 **SOLO**



- | | |
|--------------------|------------------|
| Material | AISI 304 |
| Finishing | Brushed |
| Inner Corner | '0' Radius angle |
| Overall dimensions | 850 × 450 mm |
| Basin dimensions | 810 × 350 mm |
| Bowl depth | 210 mm |
| Plus Strainer | 3 ½" |
| Cabinet size | 900 mm |
-  Top mount
 Under mount
- Cod. **SBR 81**
 Cod. **SBR ST 81**

LAYER SBR 70 **SOLO**



- | | |
|--------------------|------------------|
| Material | AISI 304 |
| Finishing | Brushed |
| Inner Corner | '0' Radius angle |
| Overall dimensions | 740 × 450 mm |
| Basin dimensions | 700 × 350 mm |
| Bowl depth | 210 mm |
| Plus Strainer | 3 ½" |
| Cabinet size | 800 mm |
-  Top mount
 Under mount
- Cod. **SBR 70**
 Cod. **SBR ST 70**

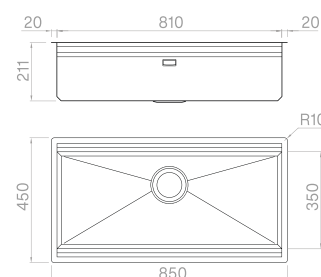

Accessories



See p. 75 for all dedicated accessories.

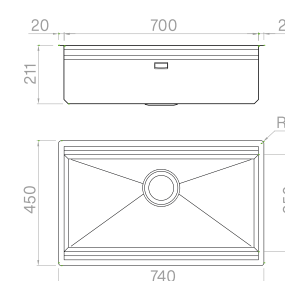

Accessories

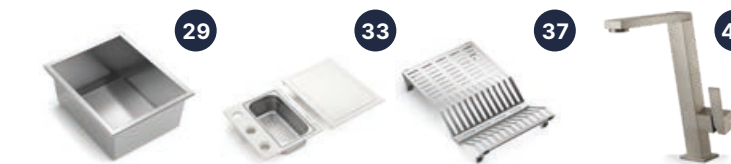

See p. 75 for all dedicated accessories.

LAYER SBR 65 **READY**



- Wooden chopping board
- Colander
- Vertigo Tap

5
22
47

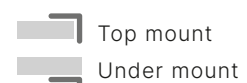

Cod. **SA SBR 65**
Cod. **SA SBR ST6**

LAYER SBR 65 **PRO**



- Wooden chopping board

5

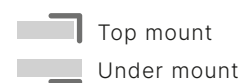

Cod. **SB SBR 65**
Cod. **SB SBR ST6**

LAYER SBR 65 **SOLO**



Material	AISI 304
Finishing	Brushed
Inner Corner	'0' Radius angle
Overall dimensions	690 × 450 mm
Basin dimensions	650 × 350 mm
Bowl depth	210 mm
Plus Strainer	3 ½"
Cabinet size	750 mm

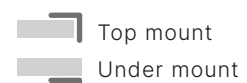

Cod. **SBR 65**
Cod. **SBR ST 65**

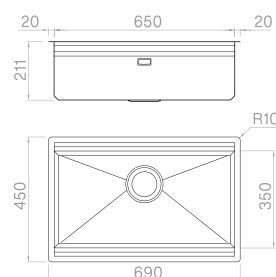

Accessories

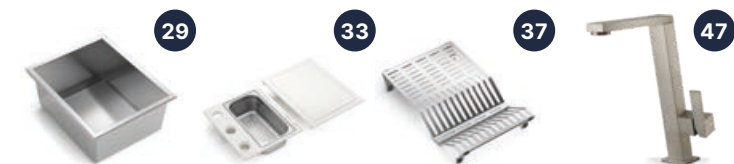

See p. 75 for all dedicated accessories.

LAYER SBR 50 **READY**



- Wooden chopping board
- Colander
- Vertigo Tap

5
22
47

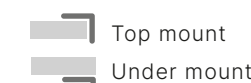

Cod. **SA SBR 50**
Cod. **SA SBR ST5**

LAYER SBR 50 **PRO**



- Wooden chopping board

5

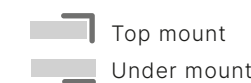

Cod. **SB SBR 50**
Cod. **SB SBR ST5**

LAYER SBR 50 **SOLO**



Material	AISI 304
Finishing	Brushed
Inner Corner	'0' Radius angle
Overall dimensions	540 × 450 mm
Basin dimensions	500 × 350 mm
Bowl depth	210 mm
Plus Strainer	3 ½"
Cabinet size	600 mm

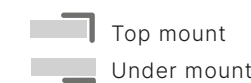

Cod. **SBR 50**
Cod. **SBR ST 50**

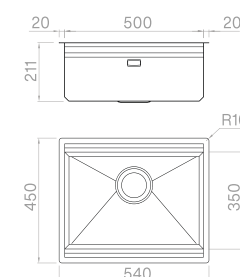

Accessories



See p. 75 for all dedicated accessories.

Wooden chopping board**5**

300×405×25 mm

Cod. **TSBR 4030****Grid****15**

300×405×25 mm

Cod. **GFL 4030****Colander****22**

190×375×80 mm

Cod. **VFP SBR19****Basin****29**

300×375×160 mm

Cod. **VGS BR34****Chopping board +
gastronorm set****31**

300×405×100 mm

Cod. **TPLB 3V****Chopping board +
pasta strainer set****33**

300×405×100 mm

Cod. **TPLB 1S****Chopping board +
knife holder frame set****35**

300×405×20 mm

Cod. **TPLB 4030****Dish holder****37**

250×400×55 mm

Cod. **PPPB SBR****Colander****49**

300×375×80 mm

Cod. **VFG SBR34**

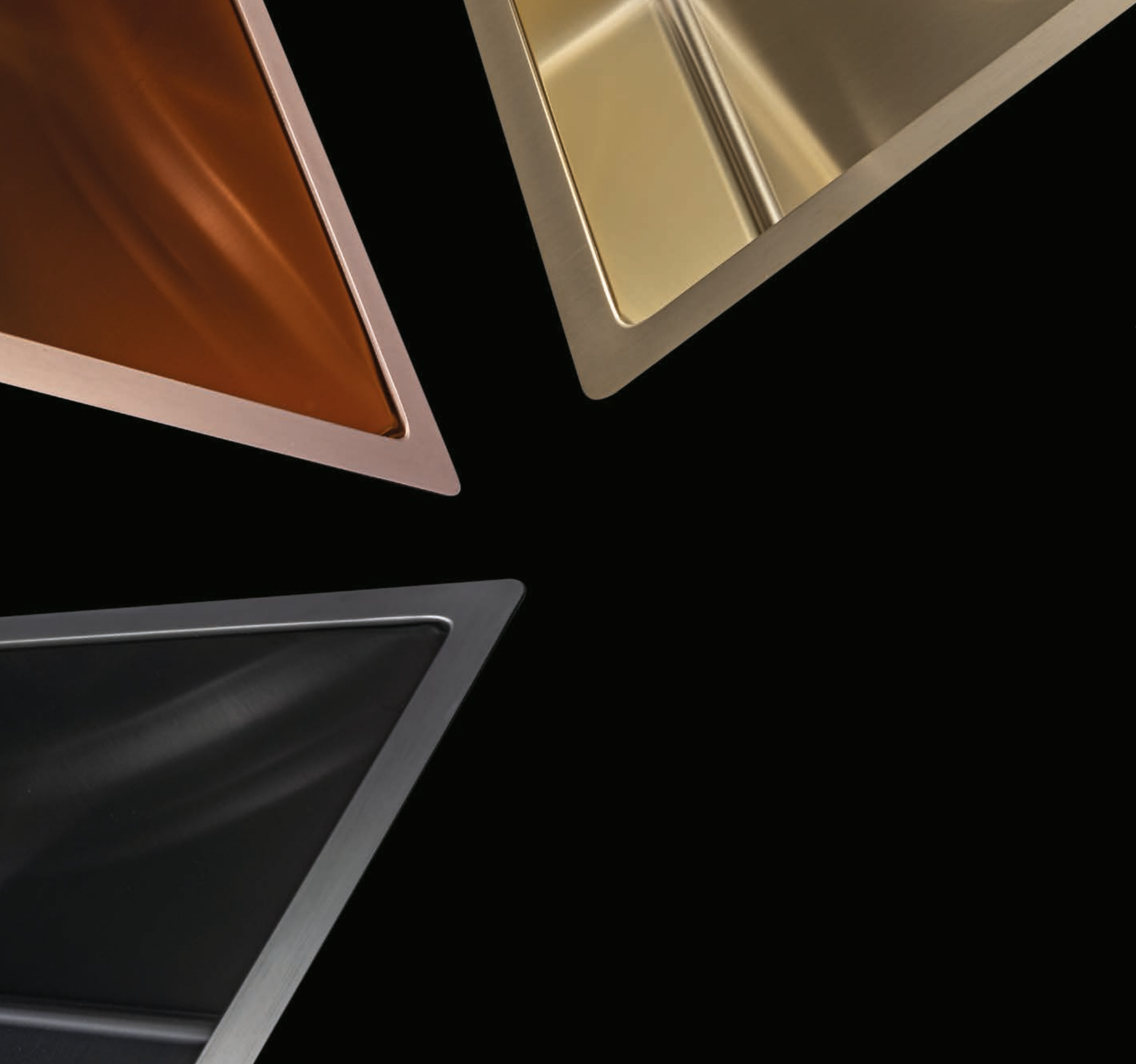

TITANIUM

The pvd is a non -toxic technology with which you can change from stainless steel to colour.

The 3 exclusive finishings gun metal, copper bronze and pale gold are applied on monochromatic solutions with a very high aesthetic impact.

TITANIUM GUN METAL







TITANIUM 70 GUN METAL

READY

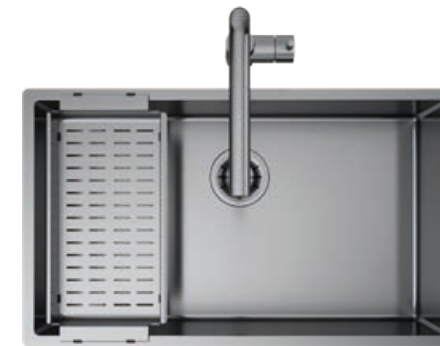
Colander Gun Metal
Athom Tap

17
42



-  Top mount
-  Flush mount
-  Under mount

Cod. **SAT I 70 RA**
Cod. **SATG 70 RA**
Cod. **SATO 70 RA**



TITANIUM 70 GUN METAL

PRO

Colander Gun Metal

17



-  Top mount
-  Flush mount
-  Under mount



Cod. **SBT I 70 RA**
Cod. **SBTG 70 RA**
Cod. **SBTO 70 RA**

TITANIUM 70 GUN METAL

SOLO



Material	AISI 304
Finishing	PVD Gun Metal
Inner Corner	R 10 mm Welded
Overall dimensions	740 × 440 mm
Basin dimensions	700 × 400 mm
Bowl depth	200 mm
Plus Strainer Gun Metal	3 1/2"
Cabinet size	800 mm

-  Top mount
 -  Flush mount
 -  Under mount
- Cod. **TI 7040 RA**
Cod. **TG 7040 RA**
Cod. **TO 7040 RA**

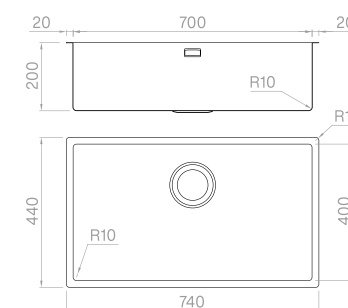

Accessories



See p. 91 for all dedicated accessories.

TITANIUM 50 GUN METAL

READY



Colander Gun Metal
Athom Tap

17
42

- Top mount
- Flush mount
- Under mount

Cod. **SAT I 50 RA**
Cod. **SATG 50 RA**
Cod. **SATO 50 RA**

TITANIUM 40 GUN METAL

READY



Colander Gun Metal
Athom Tap

17
42

- Top mount
- Flush mount
- Under mount

Cod. **SAT I 40 RA**
Cod. **SATG 40 RA**
Cod. **SATO 40 RA**

TITANIUM 50 GUN METAL

PRO



Colander Gun Metal

17

- Top mount
- Flush mount
- Under mount

Cod. **SBT I 50 RA**
Cod. **SBTG 50 RA**
Cod. **SBTO 50 RA**

TITANIUM 40 GUN METAL

PRO



Colander Gun Metal

17

- Top mount
- Flush mount
- Under mount

Cod. **SBT I 40 RA**
Cod. **SBTG 40 RA**
Cod. **SBTO 40 RA**

TITANIUM 50 GUN METAL

SOLO



Material	AISI 304
Finishing	PVD Gun Metal
Inner Corner	R 10 mm Welded
Overall dimensions	540 × 440 mm
Basin dimensions	500 × 400 mm
Bowl depth	200 mm
Plus Strainer Gun Metal	3 ½"
Cabinet size	600 mm

- Top mount
- Flush mount
- Under mount

Cod. **TI 5040 RA**
Cod. **TG 5040 RA**
Cod. **TO 5040 RA**

TITANIUM 40 GUN METAL

SOLO



Material	AISI 304
Finishing	PVD Gun Metal
Inner Corner	R 10 mm Welded
Overall dimensions	440 × 440 mm
Basin dimensions	400 × 400 mm
Bowl depth	200 mm
Plus Strainer Gun Metal	3 ½"
Cabinet size	600 mm

- Top mount
- Flush mount
- Under mount

Cod. **TI 4040 RA**
Cod. **TG 4040 RA**
Cod. **TO 4040 RA**

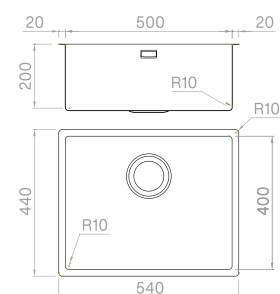

Accessories



See p. 91 for all dedicated accessories.

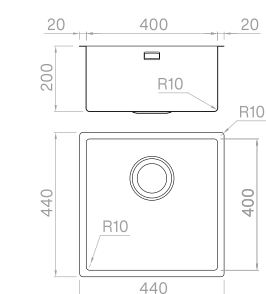

Accessories



See p. 91 for all dedicated accessories.

TITANIUM COPPER BRONZE



TITANIUM 70 COPPER BRONZE



READY

Colander Copper Bronze
Athom Tap

18

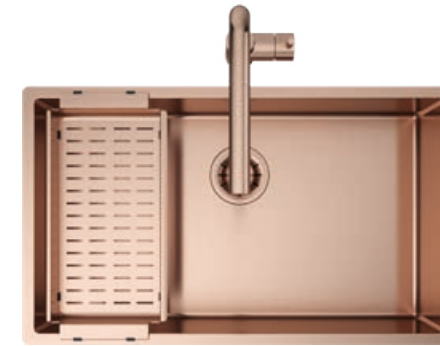
43



-  Top mount
-  Flush mount
-  Under mount

Cod. **SAT I 70 RC**
Cod. **SATG 70 RC**
Cod. **SATO 70 RC**



TITANIUM 70 COPPER BRONZE

PRO

Colander Copper Bronze

18



-  Top mount
-  Flush mount
-  Under mount



Cod. **SBT I 70 RC**
Cod. **SBTG 70 RC**
Cod. **SBTO 70 RC**

TITANIUM 70 COPPER BRONZE

SOLO



Material	AISI 304
Finishing	PVD Copper Bronze
Inner Corner	R 10 mm Welded
Overall dimensions	740 × 440 mm
Basin dimensions	700 × 400 mm
Bowl depth	200 mm
Plus Strainer Copper Bronze	3 ½"
Cabinet size	800 mm

-  Top mount
 -  Flush mount
 -  Under mount
- Cod. **TI 7040 RC**
Cod. **TG 7040 RC**
Cod. **TO 7040 RC**

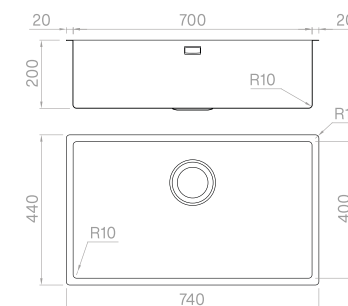

Accessories



See p. 91 for all dedicated accessories.

TITANIUM 50 COPPER BRONZE

READY



Colander Copper Bronze
Athom Tap

18
43

- Top mount
- Flush mount
- Under mount

Cod. **SAT I 50 RC**
Cod. **SATG 50 RC**
Cod. **SATO 50 RC**

TITANIUM 50 COPPER BRONZE

PRO



Colander Copper Bronze

18

- Top mount
- Flush mount
- Under mount

Cod. **SBT I 50 RC**
Cod. **SBTG 50 RC**
Cod. **SBTO 50 RC**

TITANIUM 50 COPPER BRONZE

SOLO



Material	AISI 304
Finishing	PVD Copper Bronze
Inner Corner	R 10 mm Welded
Overall dimensions	540 × 440 mm
Basin dimensions	500 × 400 mm
Bowl depth	200 mm
Plus Strainer Copper Bronze	3 ½"
Cabinet size	600 mm

- Top mount
- Flush mount
- Under mount

Cod. **TI 5040 RC**
Cod. **TG 5040 RC**
Cod. **TO 5040 RC**

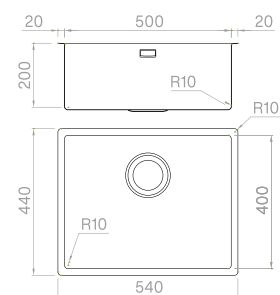

Accessories



See p. 91 for all dedicated accessories.

TITANIUM 40 COPPER BRONZE

READY



Colander Copper Bronze
Athom Tap

18
43

- Top mount
- Flush mount
- Under mount

Cod. **SAT I 40 RC**
Cod. **SATG 40 RC**
Cod. **SATO 40 RC**

TITANIUM 40 COPPER BRONZE

PRO



Colander Copper Bronze

18

- Top mount
- Flush mount
- Under mount

Cod. **SBT I 40 RC**
Cod. **SBTG 40 RC**
Cod. **SBTO 40 RC**

TITANIUM 40 COPPER BRONZE

SOLO

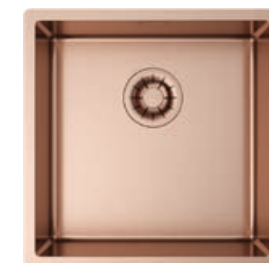

Material	AISI 304
Finishing	PVD Copper Bronze
Inner Corner	R 10 mm Welded
Overall dimensions	440 × 440 mm
Basin dimensions	400 × 400 mm
Bowl depth	200 mm
Plus Strainer Copper Bronze	3 ½"
Cabinet size	600 mm

- Top mount
- Flush mount
- Under mount

Cod. **TI 4040 RC**
Cod. **TG 4040 RC**
Cod. **TO 4040 RC**

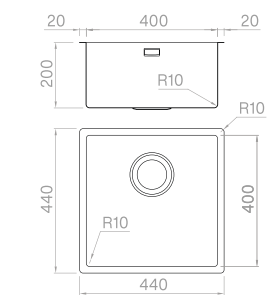

Accessories



See p. 91 for all dedicated accessories.

TITANIUM PALE GOLD







TITANIUM 70 PALE GOLD

READY

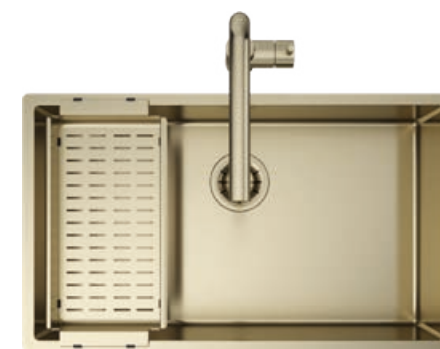
Colander Pale Gold
Athom Tap

19
44



-  Top mount
-  Flush mount
-  Under mount

Cod. **SAT I 70 RG**
Cod. **SATG 70 RG**
Cod. **SATO 70 RG**



TITANIUM 70 PALE GOLD

PRO

Colander Pale Gold

19



-  Top mount
-  Flush mount
-  Under mount



Cod. **SBT I 70 RG**
Cod. **SBTG 70 RG**
Cod. **SBTO 70 RG**

TITANIUM 70 PALE GOLD

SOLO

Material	AISI 304
Finishing	PVD Pale Gold
Inner Corner	R 10 mm Welded
Overall dimensions	740 × 440 mm
Basin dimensions	700 × 400 mm
Bowl depth	200 mm
Plus Strainer Pale Gold	3 1/2"
Cabinet size	800 mm



-  Top mount
-  Flush mount
-  Under mount

Cod. **TI 7040 RG**
Cod. **TG 7040 RG**
Cod. **TO 7040 RG**

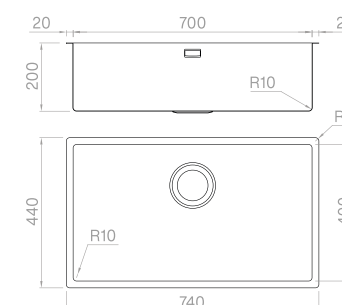

Accessories



See p. 91 for all dedicated accessories.

TITANIUM 50 PALE GOLD

READY

Colander Pale Gold
Athom Tap

19
44



- Top mount
- Flush mount
- Under mount

Cod. **SAT I 50 RG**
Cod. **SATG 50 RG**
Cod. **SATO 50 RG**

TITANIUM 50 PALE GOLD

PRO

Colander Pale Gold

19



- Top mount
- Flush mount
- Under mount

Cod. **SBT I 50 RG**
Cod. **SBTG 50 RG**
Cod. **SBTO 50 RG**

TITANIUM 50 PALE GOLD

SOLO

Material	AISI 304
Finishing	PVD Pale Gold
Inner Corner	R 10 mm Welded
Overall dimensions	540 × 440 mm
Basin dimensions	500 × 400 mm
Bowl depth	200 mm
Plus Strainer Pale Gold	3 ½"
Cabinet size	600 mm

- Top mount Cod. **TI 5040 RG**
- Flush mount Cod. **TG 5040 RG**
- Under mount Cod. **TO 5040 RG**

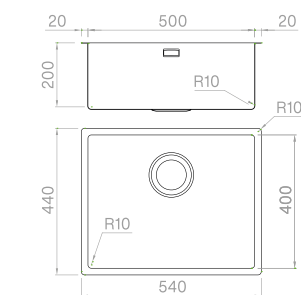

Accessories



See p. 91 for all dedicated accessories.

TITANIUM 40 PALE GOLD

READY

Colander Pale Gold
Athom Tap

19
44



- Top mount
- Flush mount
- Under mount

Cod. **SAT I 40 RG**
Cod. **SATG 40 RG**
Cod. **SATO 40 RG**

TITANIUM 40 PALE GOLD

PRO

Colander Pale Gold

19



- Top mount
- Flush mount
- Under mount

Cod. **SBT I 40 RG**
Cod. **SBTG 40 RG**
Cod. **SBTO 40 RG**

TITANIUM 40 PALE GOLD

SOLO

Material	AISI 304
Finishing	PVD Pale Gold
Inner Corner	R 10 mm Welded
Overall dimensions	440 × 440 mm
Basin dimensions	400 × 400 mm
Bowl depth	200 mm
Plus Strainer Pale Gold	3 ½"
Cabinet size	600 mm

- Top mount Cod. **TI 4040 RG**
- Flush mount Cod. **TG 4040 RG**
- Under mount Cod. **TO 4040 RG**

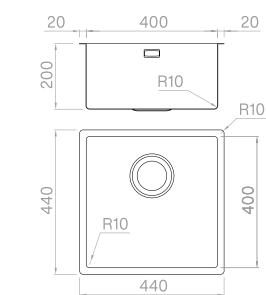

Accessories



See p. 91 for all dedicated accessories.



Wooden chopping board

3

300×420×20 mm
Cod. **TRIB 3042**



HDPE chopping board

6

240×420×20 mm
Cod. **TRP 2442**



Colander Gun Metal

17

210×420×60 mm
Cod. **VQAF 2142**

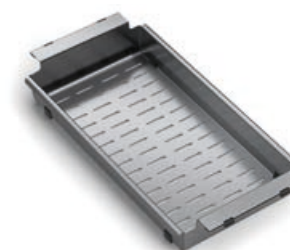

Colander Copper Bronze

18

210×420×60 mm
Cod. **VQCF 2142**



Colander Pale Gold

19

210×420×60 mm
Cod. **VQGF 2142**

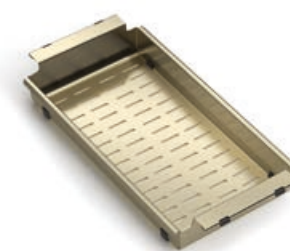

Gastronorm set

30

240×420×100 mm
Cod. **TI 2442 V**



Strainer set

32

240×420×100 mm
Cod. **TI 2442 1S**



Slicer/grater set

34

200×420×20 mm
Cod. **TI 2442 PG**



RADIUS



RADIUS MATTE VINTAGE

An elegant and sophisticated sink thanks to the combination of Matte Vintage steel and the black finish of the mixers and accessories.

Matte Vintage is an exclusive of Artinox, this finishing is characterized by a rough surface that enhances the materiality of stainless steel.



RADIUS MATTE VINTAGE 70

READY



Grid
Slanted colander
Ergo Tap

13
24
41

Top mount
Flush mount
Under mount

Cod. **SAB I 70 RH**
Cod. **SABG 70 RH**
Cod. **SABO 70 RH**

RADIUS MATTE VINTAGE 70

PRO



Slanted colander

24

Top mount
Flush mount
Under mount

Cod. **SBB I 70 RH**
Cod. **SBBG 70 RH**
Cod. **SBBO 70 RH**

RADIUS MATTE VINTAGE 70

SOLO



Material	AISI 304
Finishing	Brushed matte
Inner Corner	R 10 mm Welded
Overall dimensions	740 × 440 mm
Basin dimensions	700 × 400 mm
Bowl depth	200 mm
Black pop-up drain system	3 ½"
Cabinet size	800 mm

Top mount
Flush mount
Under mount

Cod. **BI 7040 RH**
Cod. **BG 7040 RH**
Cod. **BO 7040 RH**

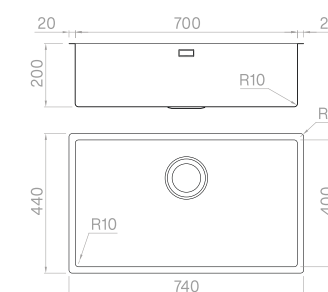

Accessories



See p. 99 for all dedicated accessories.

RADIUS MATTE VINTAGE 50

READY



Slanted colander
Ergo Tap

24
41

- Top mount
- Flush mount
- Under mount

Cod. **SAB I 50 RH**
Cod. **SABG 50 RH**
Cod. **SABO 50 RH**

RADIUS MATTE VINTAGE 50

PRO



Slanted colander

24

- Top mount
- Flush mount
- Under mount

Cod. **SBB I 50 RH**
Cod. **SBBG 50 RH**
Cod. **SBBO 50 RH**

RADIUS MATTE VINTAGE 50

SOLO



Material	AISI 304
Finishing	Brushed matte
Inner Corner	R 10 mm Welded
Overall dimensions	540 × 440 mm
Basin dimensions	500 × 400 mm
Bowl depth	200 mm
Black pop-up drain system	3 ½"
Cabinet size	600 mm

- Top mount Cod. **BI 5040 RH**
- Flush mount Cod. **BG 5040 RH**
- Under mount Cod. **BO 5040 RH**

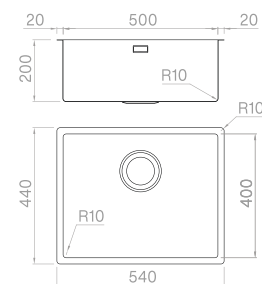

Accessories

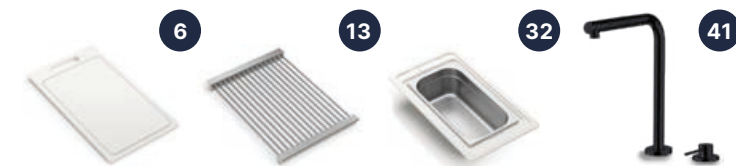

See p. 99 for all dedicated accessories.

RADIUS MATTE VINTAGE 40

READY



Slanted colander
Ergo Tap

24
41

- Top mount
- Flush mount
- Under mount

Cod. **SAB I 40 RH**
Cod. **SABG 40 RH**
Cod. **SABO 40 RH**

RADIUS MATTE VINTAGE 40

PRO



Slanted colander

24

- Top mount
- Flush mount
- Under mount

Cod. **SBB I 40 RH**
Cod. **SBBG 40 RH**
Cod. **SBBO 40 RH**

RADIUS MATTE VINTAGE 40

SOLO



Material	AISI 304
Finishing	Brushed matte
Inner Corner	R 10 mm Welded
Overall dimensions	440 × 440 mm
Basin dimensions	400 × 400 mm
Bowl depth	200 mm
Black pop-up drain system	3 ½"
Cabinet size	600 mm

- Top mount Cod. **BI 4040 RH**
- Flush mount Cod. **BG 4040 RH**
- Under mount Cod. **BO 4040 RH**

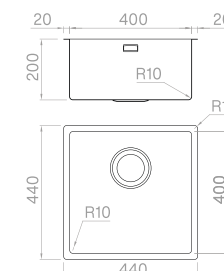

Accessories

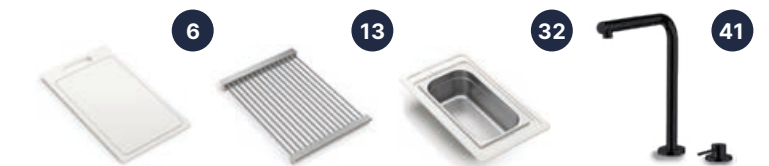

See p. 99 for all dedicated accessories.

Wooden chopping board**3**

300×420×20 mm

Cod. **TRIB 3042****HDPE chopping board****6**

240×420×20 mm

Cod. **TRP 2442****Grid mat vintage****13**

250×420×25 mm

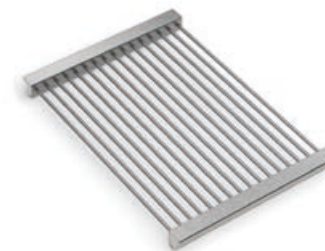
Cod. **GRH 2542****Slanted colander mat vintage****24**

280×420×110/60 mm

Cod. **VQHI 2842****Gastronorm set****30**

240×420×100 mm

Cod. **TI 2442 V****Strainer set****32**

240×420×100 mm

Cod. **TI 2442 1S****Slicer/grater set****34**

200×420×20 mm

Cod. **TI 2442 PG**

RADIUS

Radius collection offers a wide choice of sinks manufactured with 10 mm internal radius corners. Precision added to essentiality of geometries.



RADIUS 81

READY



- Wooden chopping board
- Slanted colander
- Basin
- Element Tap

- 3
- 23
- 26
- 40

- Top mount
- Flush mount
- Under mount

- Cod. **SAB I 81 R1**
- Cod. **SABG 81 R1**
- Cod. **SABO 81 R1**

RADIUS 81

PRO



- Colander

- 16

- Top mount
- Flush mount
- Under mount

- Cod. **SBB I 81 R1**
- Cod. **SBBG 81 R1**
- Cod. **SBBO 81 R1**

RADIUS 81

SOLO



- Material: AISI 304
- Finishing: Brushed
- Inner Corner: R 10 mm Welded
- Overall dimensions: 850 × 440 mm
- Basin dimensions: 810 × 400 mm
- Bowl depth: 200 mm
- Pop-up drain system: 3 1/2"
- Cabinet size: 900 mm

- Top mount
- Flush mount
- Under mount

- Cod. **BI 8140 R1**
- Cod. **BG 8140 R1**
- Cod. **BO 8140 R1**

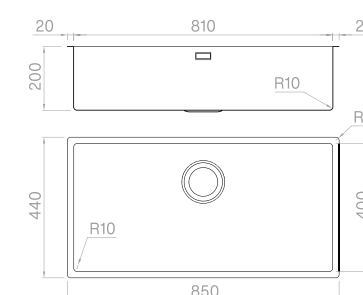

Accessories

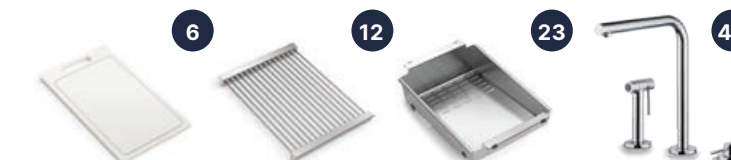

See p. 109 for all dedicated accessories.

RADIUS 70

READY



- Wooden chopping board
- Slanted colander
- Basin
- Element Tap

- 3
- 23
- 26
- 40

- Top mount
- Flush mount
- Under mount

- Cod. **SAB I 70 R1**
- Cod. **SABG 70 R1**
- Cod. **SABO 70 R1**

RADIUS 65

READY



- Wooden chopping board
- Slanted colander
- Hero Tap

- 3
- 23
- 39

- Top mount
- Flush mount
- Under mount

- Cod. **SAB I 65 R1**
- Cod. **SABG 65 R1**
- Cod. **SABO 65 R1**

RADIUS 70

PRO



- Colander

- 16

- Top mount
- Flush mount
- Under mount

- Cod. **SBB I 70 R1**
- Cod. **SBBG 70 R1**
- Cod. **SBBO 70 R1**

RADIUS 65

PRO



- Colander

- 16

- Top mount
- Flush mount
- Under mount

- Cod. **SBB I 65 R1**
- Cod. **SBBG 65 R1**
- Cod. **SBBO 65 R1**

RADIUS 70

SOLO



- Material: AISI 304
- Finishing: Brushed
- Inner Corner: R 10 mm Welded
- Overall dimensions: 740 × 440 mm
- Basin dimensions: 700 × 400 mm
- Bowl depth: 200 mm
- Pop-up drain system: 3 ½"
- Cabinet size: 800 mm

- Top mount
- Flush mount
- Under mount

- Cod. **BI 7040 R1**
- Cod. **BG 7040 R1**
- Cod. **BO 7040 R1**

RADIUS 65

SOLO



- Material: AISI 304
- Finishing: Brushed
- Inner Corner: R 10 mm Welded
- Overall dimensions: 690 × 440 mm
- Basin dimensions: 650 × 400 mm
- Bowl depth: 200 mm
- Pop-up drain system: 3 ½"
- Cabinet size: 750 mm

- Top mount
- Flush mount
- Under mount

- Cod. **BI 6540 R1**
- Cod. **BG 6540 R1**
- Cod. **BO 6540 R1**

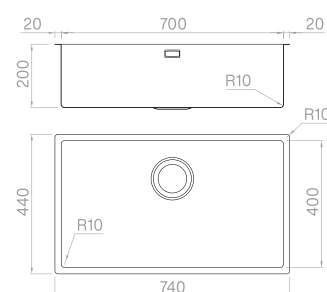

Accessories

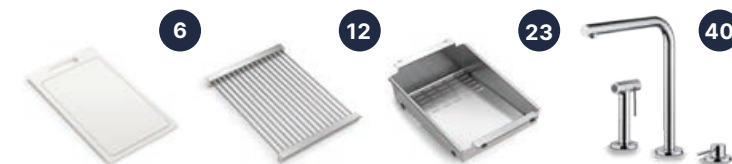

See p. 109 for all dedicated accessories.

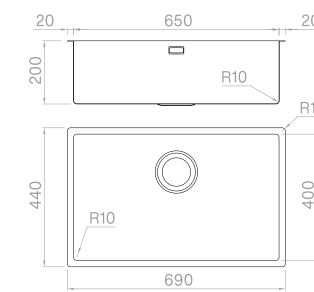

Accessories

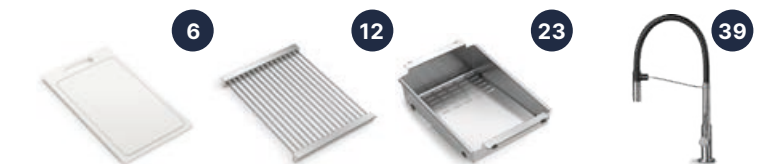

See p. 109 for all dedicated accessories.

RADIUS 50

READY



- Wooden chopping board
- Slanted colander
- Hero Tap

3
23
39

- Top mount
- Flush mount
- Under mount

Cod. **SAB I 50 R1**
Cod. **SABG 50 R1**
Cod. **SABO 50 R1**

RADIUS 50

PRO



- Colander

16

- Top mount
- Flush mount
- Under mount

Cod. **SBB I 50 R1**
Cod. **SBBG 50 R1**
Cod. **SBBO 50 R1**

RADIUS 50

SOLO



- Material: AISI 304
- Finishing: Brushed
- Inner Corner: R 10 mm Welded
- Overall dimensions: 540 × 440 mm
- Basin dimensions: 500 × 400 mm
- Bowl depth: 200 mm
- Pop-up drain system: 3 ½"
- Cabinet size: 600 mm

- Top mount
- Flush mount
- Under mount

Cod. **BI 5040 R1**
Cod. **BG 5040 R1**
Cod. **BO 5040 R1**

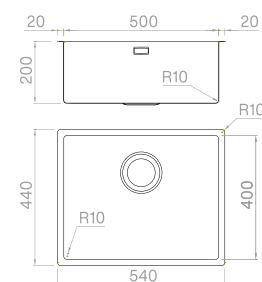

Accessories

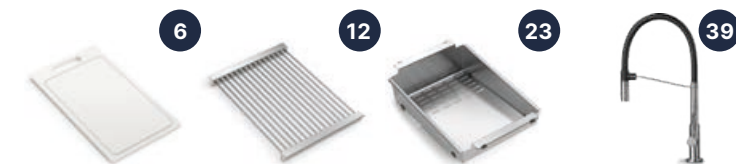

See p. 109 for all dedicated accessories.

RADIUS 45

READY

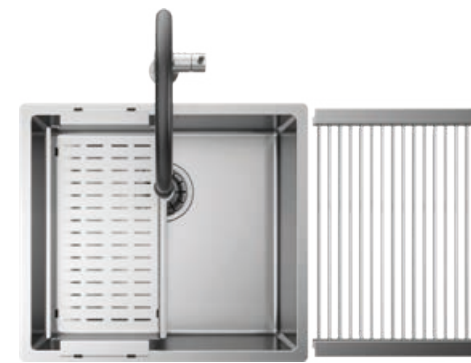

- Grid
- Colander
- Hero Tap

12
16
39

- Top mount
- Flush mount
- Under mount

Cod. **SAB I 45 R1**
Cod. **SABG 45 R1**
Cod. **SABO 45 R1**

RADIUS 45

PRO



- Colander

16

- Top mount
- Flush mount
- Under mount

Cod. **SBB I 45 R1**
Cod. **SBBG 45 R1**
Cod. **SBBO 45 R1**

RADIUS 45

SOLO



- Material: AISI 304
- Finishing: Brushed
- Inner Corner: R 10 mm Welded
- Overall dimensions: 490 × 440 mm
- Basin dimensions: 450 × 400 mm
- Bowl depth: 200 mm
- Pop-up drain system: 3 ½"
- Cabinet size: 600 mm

- Top mount
- Flush mount
- Under mount

Cod. **BI 4540 R1**
Cod. **BG 4540 R1**
Cod. **BO 4540 R1**

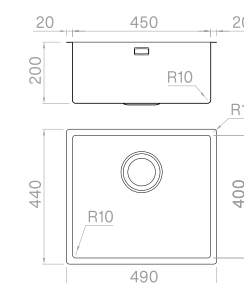

Accessories

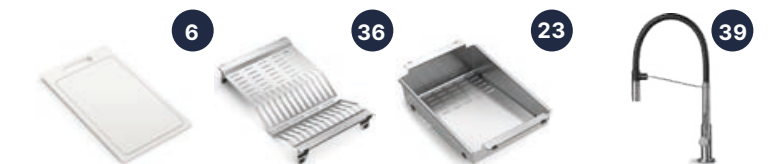

See p. 109 for all dedicated accessories.

RADIUS 40 + 34

READY

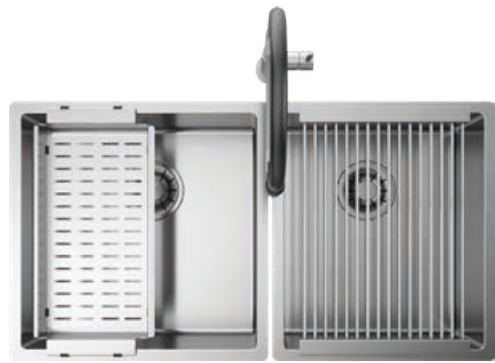

Grid
Colander
Hero Tap

12
16
39

Top mount
Flush mount
Under mount

Cod. **SAB I 40 R1**
Cod. **SABG 40 R1**
Cod. **SABO 40 R1**

RADIUS 34+34

READY

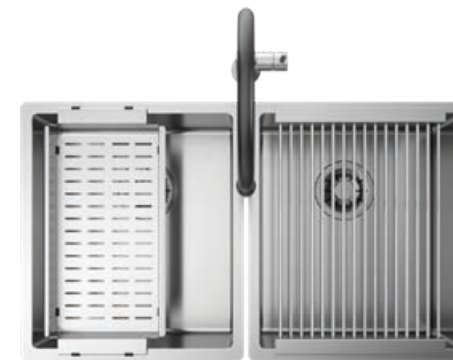

Grid
Colander
Hero Tap

12
16
39

Top mount
Flush mount
Under mount

Cod. **SAB I 34 R1**
Cod. **SABG 34 R1**
Cod. **SABO 34 R1**

RADIUS 40

PRO

Colander

16



Top mount
Flush mount
Under mount

Cod. **SBB I 40 R1**
Cod. **SBBG 40 R1**
Cod. **SBBO 40 R1**

RADIUS 34

PRO

Colander

16



Top mount
Flush mount
Under mount

Cod. **SBB I 34 R1**
Cod. **SBBG 34 R1**
Cod. **SBBO 34 R1**

RADIUS 40

SOLO



Material	AISI 304
Finishing	Brushed
Inner Corner	R 10 mm Welded
Overall dimensions	440 × 440 mm
Basin dimensions	400 × 400 mm
Bowl depth	200 mm
Pop-up drain system	3 ½"
Cabinet size	600 mm

Top mount
Flush mount
Under mount

Cod. **BI 4040 R1**
Cod. **BG 4040 R1**
Cod. **BO 4040 R1**

RADIUS 34

SOLO



Material	AISI 304
Finishing	Brushed
Inner Corner	R 10 mm Welded
Overall dimensions	380 × 440 mm
Basin dimensions	340 × 400 mm
Bowl depth	200 mm
Pop-up drain system	3 ½"
Cabinet size	600 mm

Top mount
Flush mount
Under mount

Cod. **BI 3440 R1**
Cod. **BG 3440 R1**
Cod. **BO 3440 R1**

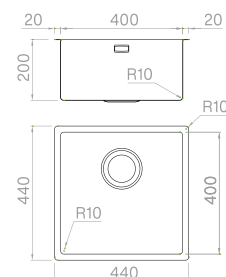

Accessories



See p. 109 for all dedicated accessories.

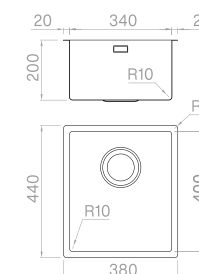

Accessories

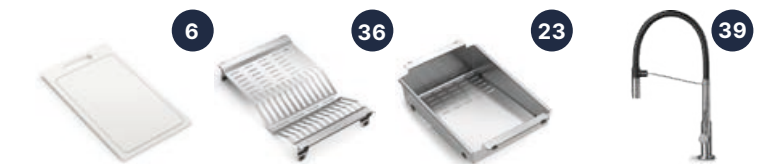

See p. 109 for all dedicated accessories.

**Wooden chopping board****3**

300×420×20 mm
Cod. **TRIB 3042**

**HDPE chopping board****6**

240×420×20 mm
Cod. **TRP 2442**

**Grid****12**

250×420×25 mm
Cod. **GRS 2542**

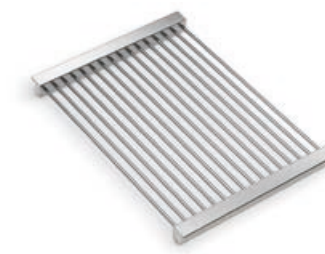
**Colander****16**

210×420×60 mm
Cod. **VQSF 2142**

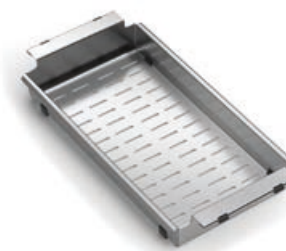
**Slanted colander****23**

280×420×110/60 mm
Cod. **VQSI 2842**

**Basin****26**

280×420×160 mm
Cod. **VQSP 2842**

**Gastronorm set****30**

240×420×100 mm
Cod. **TI 2442 V**

**Strainer set****32**

240×420×100 mm
Cod. **TI 2442 1S**

**Slicer/grater set****34**

200×420×20 mm
Cod. **TI 2442 PG**

**Plate holder****36**

250×420×55 mm
Cod. **PPPB V400**



GHOST

The rear lowered couterbank of the sink allows to house the mixer within the operating area: a brilliant solution, small space, premium quality.





GHOST 60

READY



- Strainer set **32**
- HDPE chopping board **6**
- Circle Tap **45**



-  Top mount Cod. **SAG I 60 RM**
-  Flush mount Cod. **SAGF 60 RM**
-  Under mount Cod. **SAGO 60 RM**

GHOST 60

PRO



- HDPE chopping board **6**



-  Top mount Cod. **SBG I 60 RM**
-  Flush mount Cod. **SBGF 60 RM**
-  Under mount Cod. **SBGO 60 RM**

GHOST 60

SOLO



- Material AISI 304
- Finishing Brushed
- Inner Corner R 10 mm Welded
- Overall dimensions 440 × 520 mm
- Basin dimensions 400 × 400 + 80 mm
- Bowl depth 65/200 mm
- Plus Strainer 3 1/2"
- Cabinet size 600 mm

-  Top mount Cod. **SIG 60 RM**
-  Flush mount Cod. **SFG 60 RM**
-  Under mount Cod. **SSG 60 RM**

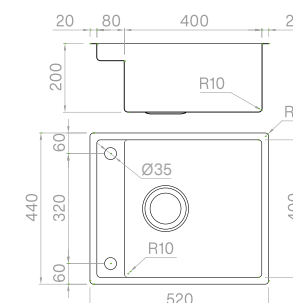

Accessories

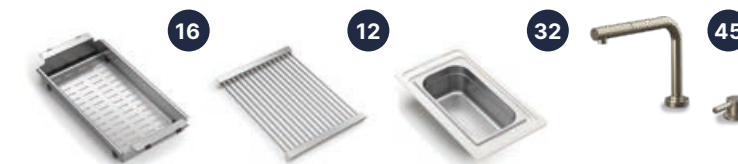

See p. 113 for all dedicated accessories.

**Wooden chopping board****3**

300×420×20 mm
Cod. **TRIB 3042**

**HDPE chopping board****6**

240×420×20 mm
Cod. **TRP 2442**

**Grid****12**

250×420×25 mm
Cod. **GRS 2542**

**Colander****16**

210×420×60 mm
Cod. **VQSF 2142**

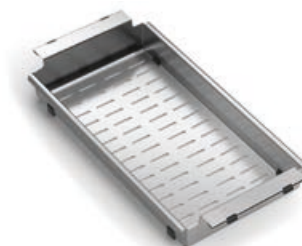
**Gastronorm set****30**

240×420×100 mm
Cod. **TI 2442 V**

**Strainer set****32**

240×420×100 mm
Cod. **TI 2442 1S**

**Slicer/grater set****34**

200×420×20 mm
Cod. **TI 2442 PG**

**Plate holder****36**

250×420×55 mm
Cod. **PPPB V400**



MOSE

Mose range offers double sinks with lowered bridge, accessories can easily slide on the entire surface. In some models the mixer is positioned inside the operating area.



MOSE BR 81 **READY**

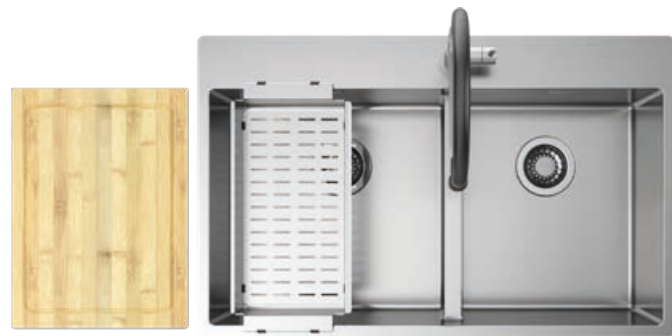

Wooden chopping board
Colander
Hero Tap

3
16
39

Top mount
Flush mount

Cod. **SAM BR I 81**
Cod. **SAM BRG 81**

MOSE BR 81 **PRO**



Colander

16

Top mount
Flush mount

Cod. **SBM BR I 81**
Cod. **SBM BRG 81**

MOSE BR 81 **SOLO**



Material	AISI 304
Finishing	Brushed
Inner Corner	R 10 mm Welded
Overall dimensions	810 × 510 mm
Basin dimensions	400 × 400 mm / 340 × 400 mm
Bowl depth	200 mm
Pop-up drain system	3 ½"
Cabinet size	900 mm

Top mount
Flush mount

Cod. **ALM BR I 81**
Cod. **ALM BRG 81**

Mixer hole: specify extra holes when ordering.

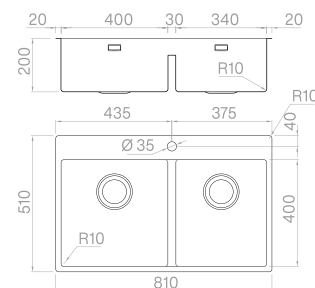

Accessories

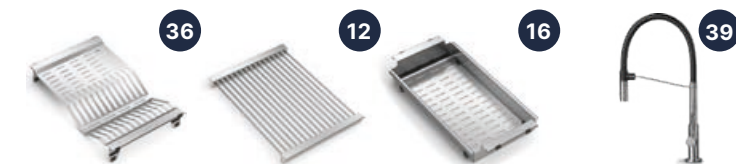

See p. 121 for all dedicated accessories.

MOSE BR 60 **READY**



Wooden chopping board
Colander
Hero Tap

3
16
39

Top mount
Flush mount

Cod. **SAM BR I 60**
Cod. **SAM BRG 60**

MOSE BR 60 **PRO**



Colander

16

Top mount
Flush mount

Cod. **SBM BR I 60**
Cod. **SBM BRG 60**

MOSE BR 60 **SOLO**



Material	AISI 304
Finishing	Brushed
Inner Corner	R 10 mm Welded
Overall dimensions	590 × 510 mm
Basin dimensions	180 × 400 mm / 340 × 400 mm
Bowl depth	170 / 200 mm
Pop-up drain system	3 ½"
Cabinet size	600 mm

Top mount
Flush mount

Cod. **ALM BR I 60**
Cod. **ALM BRG 60**

Mixer hole: specify extra holes when ordering.

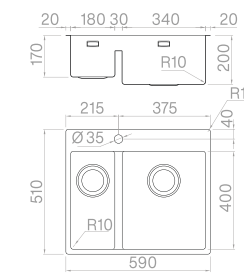

Accessories

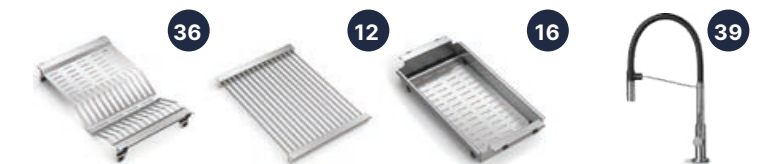

See p. 121 for all dedicated accessories.

MOSE SB 81 **READY**

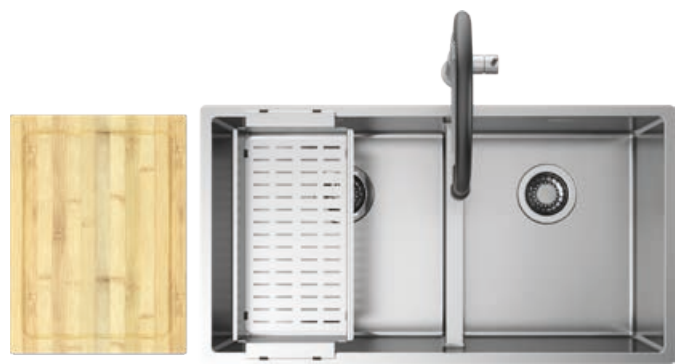

- Wooden chopping board
- Colander
- Hero Tap

3
16
39

- Top mount
- Flush mount
- Under mount

Cod. **SAM I 81 R1**
Cod. **SAMG 81 R1**
Cod. **SAMO 81 R1**

MOSE SB 81 **PRO**



- Colander

16

- Top mount
- Flush mount
- Under mount

Cod. **SBM I 81 R1**
Cod. **SBMG 81 R1**
Cod. **SBMO 81 R1**

MOSE SB 81 **SOLO**



- | | |
|---------------------|-----------------------------|
| Material | AISI 304 |
| Finishing | Brushed |
| Inner Corner | R 10 mm Welded |
| Overall dimensions | 810 × 440 mm |
| Basin dimensions | 400 × 400 mm / 340 × 400 mm |
| Bowl depth | 200 mm |
| Pop-up drain system | 3 ½" |
| Cabinet size | 900 mm |

- Top mount
- Flush mount
- Under mount

Cod. **MI 8140 R1**
Cod. **MG 8140 R1**
Cod. **MO 8140 R1**

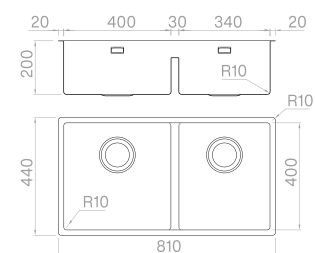

Accessories



See p. 121 for all dedicated accessories.

MOSE SB 60 **READY**

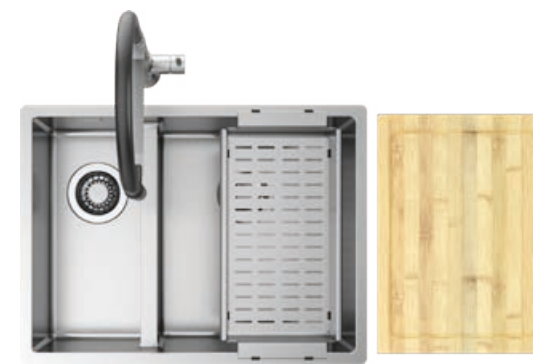

- Wooden chopping board
- Colander
- Hero Tap

3
16
39

- Top mount
- Flush mount
- Under mount

Cod. **SAM I 60 R1**
Cod. **SAMG 60 R1**
Cod. **SAMO 60 R1**

MOSE SB 60 **PRO**



- Colander

16

- Top mount
- Flush mount
- Under mount

Cod. **SBM I 60 R1**
Cod. **SBMG 60 R1**
Cod. **SBMO 60 R1**

MOSE SB 60 **SOLO**



- | | |
|---------------------|-----------------------------|
| Material | AISI 304 |
| Finishing | Brushed |
| Inner Corner | R 10 mm Welded |
| Overall dimensions | 590 × 440 mm |
| Basin dimensions | 180 × 400 mm / 340 × 400 mm |
| Bowl depth | 170 / 200 mm |
| Pop-up drain system | 3 ½" |
| Cabinet size | 600 mm |

- Top mount
- Flush mount
- Under mount

Cod. **MI 6040 R1**
Cod. **MG 6040 R1**
Cod. **MO 6040 R1**

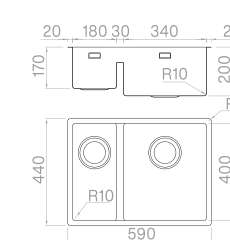

Accessories

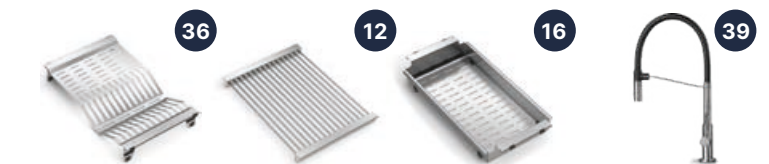

See p. 121 for all dedicated accessories.

Wooden chopping board**3**300×420×20 mm
Cod. **TRIB 3042****HDPE chopping board****6**240×420×20 mm
Cod. **TRP 2442****Grid****12**250×420×25 mm
Cod. **GRS 2542****Colander****16**210×420×60 mm
Cod. **VQSF 2142****Plate holder****36**250×420×55 mm
Cod. **PPPB V400**

AQUA

Aqua range offers sinks with generous capacity and essential design thanks to 10 mm internal angles. The positioning of the mixer is inside the operating area.



AQUA 81

READY



Wooden chopping board
Colander
Hero Tap

3
16
39

Top mount
Flush mount

Cod. **SAA I 81**
Cod. **SAAG 81**

AQUA 81

PRO



Colander

16

Top mount
Flush mount

Cod. **SBA I 81**
Cod. **SBAG 81**

AQUA 81

SOLO



Material	AISI 304
Finishing	Brushed
Inner Corner	R 10 mm Welded
Overall dimensions	850 × 510 mm
Basin dimensions	810 × 400 mm
Bowl depth	200 mm
Pop-up drain system	3 ½"
Cabinet size	900 mm

Top mount
Flush mount

Cod. **ALA I 81**
Cod. **ALAG 81**

Mixer hole: specify extra holes when ordering.

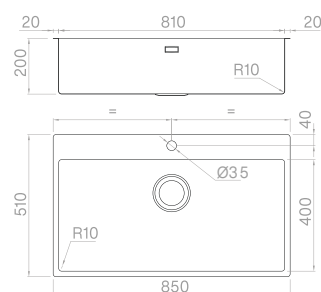

Accessories

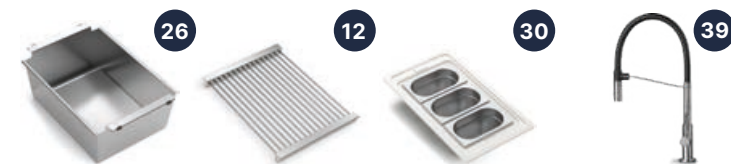

See p. 129 for all dedicated accessories.

AQUA 70

READY

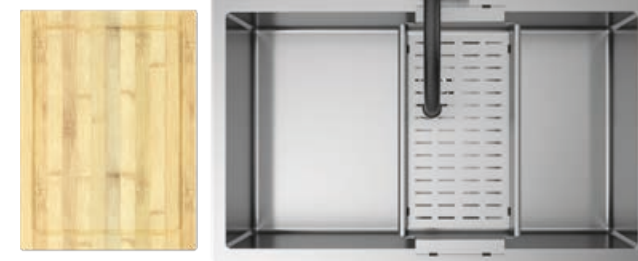

Wooden chopping board
Colander
Hero Tap

3
16
39

Top mount
Flush mount

Cod. **SAA I 70**
Cod. **SAAG 70**

AQUA 70

PRO



Colander

16

Top mount
Flush mount

Cod. **SBA I 70**
Cod. **SBAG 70**

AQUA 70

SOLO



Material	AISI 304
Finishing	Brushed
Inner Corner	R 10 mm Welded
Overall dimensions	740 × 510 mm
Basin dimensions	700 × 400 mm
Bowl depth	200 mm
Pop-up drain system	3 ½"
Cabinet size	800 mm

Top mount
Flush mount

Cod. **ALA I 70**
Cod. **ALAG 70**

Mixer hole: specify extra holes when ordering.

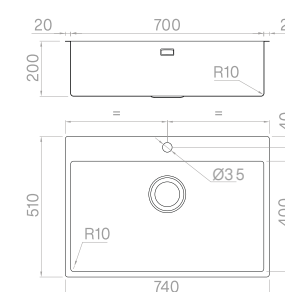

Accessories

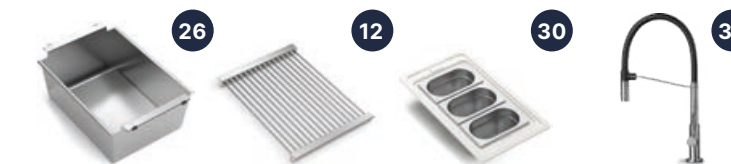

See p. 129 for all dedicated accessories.

AQUA 65

READY



- Wooden chopping board
- Colander
- Hero Tap

3
16
39



Cod. **SAA I 65**
Cod. **SAAG 65**

AQUA 65

PRO



- Colander

16

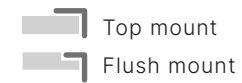

Cod. **SBA I 65**
Cod. **SBAG 65**

AQUA 65

SOLO



- Material: AISI 304
- Finishing: Brushed
- Inner Corner: R 10 mm Welded
- Overall dimensions: 690 × 510 mm
- Basin dimensions: 650 × 400 mm
- Bowl depth: 200 mm
- Pop-up drain system: 3 ½"
- Cabinet size: 750 mm

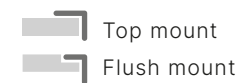

Cod. **ALA I 65**
Cod. **ALAG 65**

Mixer hole: specify extra holes when ordering.

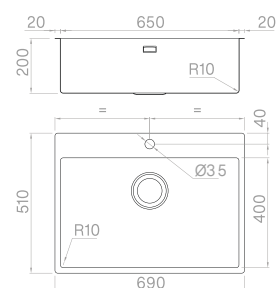

Accessories

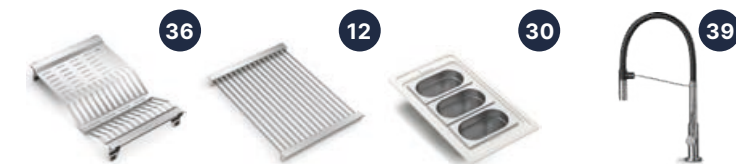

See p. 129 for all dedicated accessories.

AQUA 50

READY

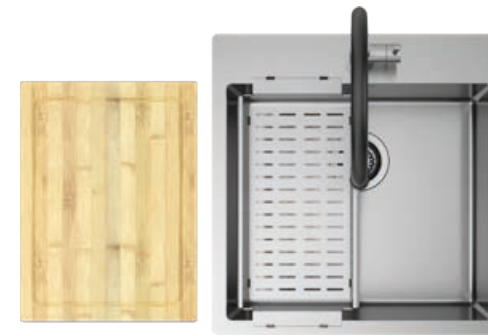

- Wooden chopping board
- Colander
- Hero Tap

3
16
39

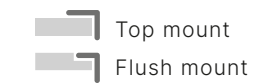

Cod. **SAA I 50**
Cod. **SAAG 50**

AQUA 50

PRO



- Colander

16

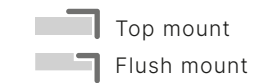

Cod. **SBA I 50**
Cod. **SBAG 50**

AQUA 50

SOLO



- Material: AISI 304
- Finishing: Brushed
- Inner Corner: R 10 mm Welded
- Overall dimensions: 540 × 510 mm
- Basin dimensions: 500 × 400 mm
- Bowl depth: 200 mm
- Pop-up drain system: 3 ½"
- Cabinet size: 600 mm

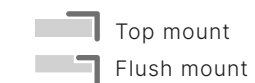

Cod. **ALA I 50**
Cod. **ALAG 50**

Mixer hole: specify extra holes when ordering.

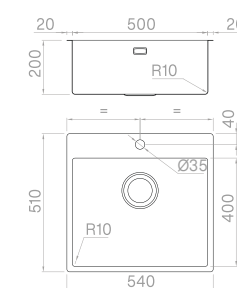

Accessories

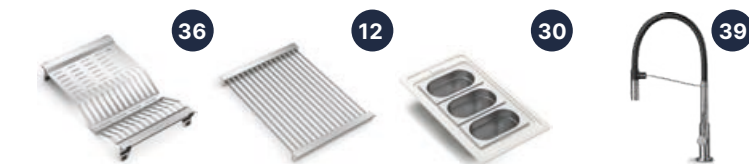

See p. 129 for all dedicated accessories.

**Wooden chopping board****3**

300×420×20 mm
Cod. **TRIB 3042**

**HDPE chopping board****6**

240×420×20 mm
Cod. **TRP 2442**

**Grid****12**

250×420×25 mm
Cod. **GRS 2542**

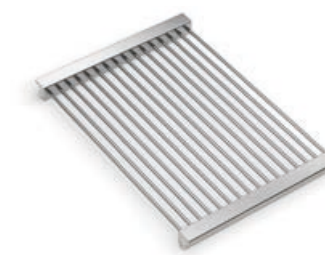
**Colander****16**

210×420×60 mm
Cod. **VQSF 2142**

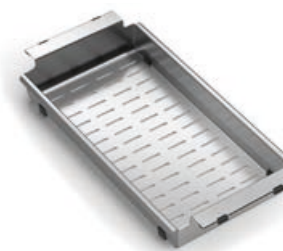
**Slanted colander****23**

280×420×110/60 mm
Cod. **VQSI 2842**

**Basin****26**

280×420×160 mm
Cod. **VQSP 2842**

**Gastronorm set****30**

240×420×100 mm
Cod. **TI 2442 V**

**Strainer set****32**

240×420×100 mm
Cod. **TI 2442 1S**

**Slicer/grater set****34**

200×420×20 mm
Cod. **TI 2442 PG**

**Plate holder****36**

250×420×55 mm
Cod. **PPPB V400**





PRISMA

A perfect combination of precision and geometry. In this collection the side corners with zero radius are linked to the bottom, where the perimeter is tilted to 45°.



PRISMA 81

READY



- Wooden chopping board
- Slanted colander
- Basin
- Element Tap

- 3
- 23
- 26
- 40

- Top mount
- Flush mount
- Under mount

- Cod. **SAPR I 81**
- Cod. **SAPRG 81**
- Cod. **SAPRO 81**

PRISMA 81

PRO



- Colander

- 16

- Top mount
- Flush mount
- Under mount

- Cod. **SBPR I 81**
- Cod. **SBPRG 81**
- Cod. **SBPRO 81**

PRISMA 81

SOLO



- Material: AISI 304
- Finishing: Brushed
- Inner Corner: R 0 mm Welded
- Overall dimensions: 850 × 440 mm
- Basin dimensions: 810 × 400 mm
- Bowl depth: 200 mm
- Pop-up drain system: 3 1/2"
- Cabinet size: 900 mm

- Top mount
- Flush mount
- Under mount

- Cod. **PR I 81**
- Cod. **PR G 81**
- Cod. **PR O 81**

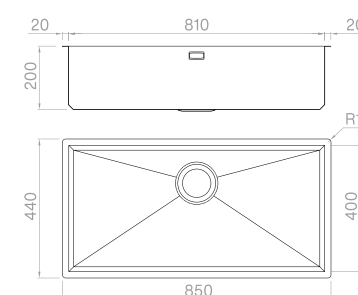

Accessories

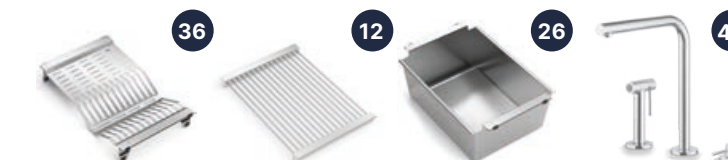

See p. 141 for all dedicated accessories.

PRISMA 70

READY



- Wooden chopping board
- Slanted colander
- Basin
- Element Tap

- 3
- 23
- 26
- 40

- Top mount
- Flush mount
- Under mount

- Cod. **SAPR I 70**
- Cod. **SAPRG 70**
- Cod. **SAPRO 70**

PRISMA 70

PRO



- Colander

- 16

- Top mount
- Flush mount
- Under mount

- Cod. **SBPR I 70**
- Cod. **SBPRG 70**
- Cod. **SBPRO 70**

PRISMA 70

SOLO



- Material: AISI 304
- Finishing: Brushed
- Inner Corner: R 0 mm Welded
- Overall dimensions: 740 × 440 mm
- Basin dimensions: 700 × 400 mm
- Bowl depth: 200 mm
- Pop-up drain system: 3 ½"
- Cabinet size: 800 mm

- Top mount
- Flush mount
- Under mount

- Cod. **PR I 70**
- Cod. **PR G 70**
- Cod. **PR O 70**

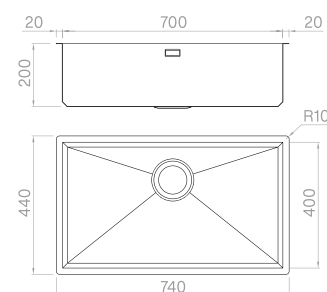

Accessories

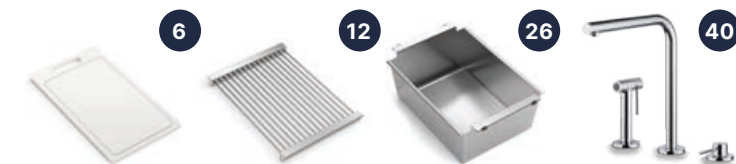

See p. 141 for all dedicated accessories.

PRISMA 65

READY



- Wooden chopping board
- Slanted colander
- Vertigo Tap

- 3
- 23
- 47

- Top mount
- Flush mount
- Under mount

- Cod. **SAPR I 65**
- Cod. **SAPRG 65**
- Cod. **SAPRO 65**

PRISMA 65

PRO



- Colander

- 16

- Top mount
- Flush mount
- Under mount

- Cod. **SBPR I 65**
- Cod. **SBPRG 65**
- Cod. **SBPRO 65**

PRISMA 65

SOLO



- Material: AISI 304
- Finishing: Brushed
- Inner Corner: R 0 mm Welded
- Overall dimensions: 690 × 440 mm
- Basin dimensions: 650 × 400 mm
- Bowl depth: 200 mm
- Pop-up drain system: 3 ½"
- Cabinet size: 750 mm

- Top mount
- Flush mount
- Under mount

- Cod. **PR I 65**
- Cod. **PR G 65**
- Cod. **PR O 65**

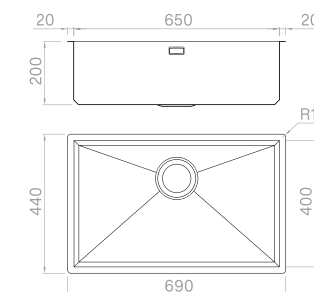

Accessories

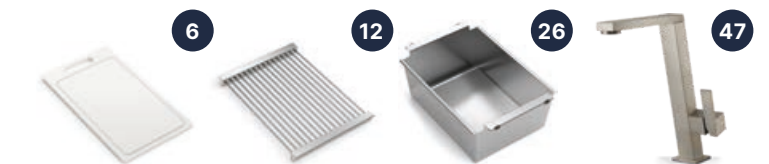

See p. 141 for all dedicated accessories.

PRISMA 50

READY



- Wooden chopping board
- Slanted colander
- Vertigo Tap

3
23
47

- Top mount
- Flush mount
- Under mount

Cod. **SAPR I 50**
Cod. **SAPRG 50**
Cod. **SAPRO 50**

PRISMA 50

PRO



- Colander

16

- Top mount
- Flush mount
- Under mount

Cod. **SBPR I 50**
Cod. **SBPRG 50**
Cod. **SBPRO 50**

PRISMA 50

SOLO



- Material: AISI 304
- Finishing: Brushed
- Inner Corner: R 0 mm Welded
- Overall dimensions: 540 × 440 mm
- Basin dimensions: 500 × 400 mm
- Bowl depth: 200 mm
- Pop-up drain system: 3 ½"
- Cabinet size: 600 mm

- Top mount
- Flush mount
- Under mount

Cod. **PR I 50**
Cod. **PR G 50**
Cod. **PR O 50**

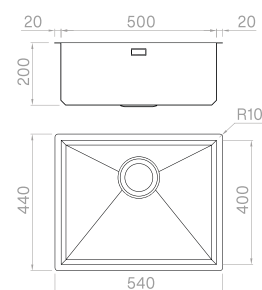

Accessories

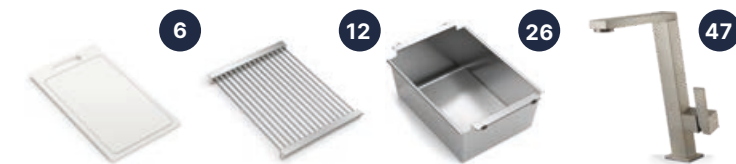

See p. 141 for all dedicated accessories.

PRISMA 45

READY

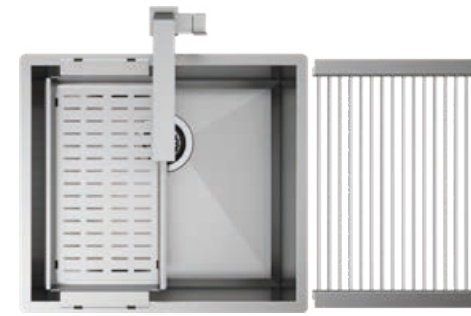

- Grid
- Colander
- Vertigo Tap

12
16
47

- Top mount
- Flush mount
- Under mount

Cod. **SAPR I 45**
Cod. **SAPRG 45**
Cod. **SAPRO 45**

PRISMA 45

PRO



- Colander

16

- Top mount
- Flush mount
- Under mount

Cod. **SBPR I 45**
Cod. **SBPRG 45**
Cod. **SBPRO 45**

PRISMA 45

SOLO



- Material: AISI 304
- Finishing: Brushed
- Inner Corner: R 0 mm Welded
- Overall dimensions: 490 × 440 mm
- Basin dimensions: 450 × 400 mm
- Bowl depth: 200 mm
- Pop-up drain system: 3 ½"
- Cabinet size: 600 mm

- Top mount
- Flush mount
- Under mount

Cod. **PR I 45**
Cod. **PR G 45**
Cod. **PR O 45**

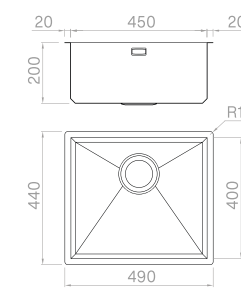

Accessories



See p. 141 for all dedicated accessories.

PRISMA 40 + 34

READY

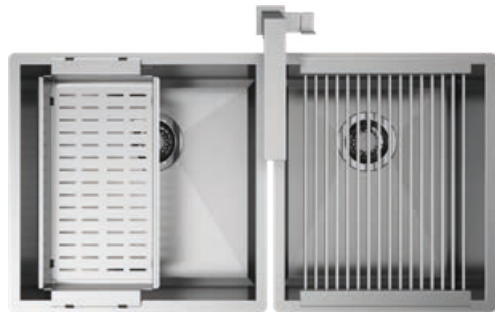

- Grid **12**
- Colander **16**
- Vertigo Tap **47**

- Top mount Cod. **SAPR I 40**
- Flush mount Cod. **SAPRG 40**
- Under mount Cod. **SAPRO 40**

PRISMA 34 + 34

READY

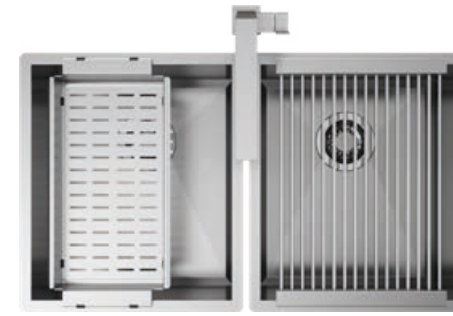

- Grid **12**
- Colander **16**
- Vertigo Tap **47**

- Top mount Cod. **SAPR I 34**
- Flush mount Cod. **SAPRG 34**
- Under mount Cod. **SAPRO 34**

PRISMA 40

PRO

- Colander **16**



- Top mount Cod. **SBPR I 40**
- Flush mount Cod. **SBPRG 40**
- Under mount Cod. **SBPRO 40**

PRISMA 34

PRO

- Colander **16**



- Top mount Cod. **SBPR I 34**
- Flush mount Cod. **SBPRG 34**
- Under mount Cod. **SBPRO 34**

PRISMA 40

SOLO

- Material AISI 304
- Finishing Brushed
- Inner Corner R 0 mm Welded
- Overall dimensions 440 × 440 mm
- Basin dimensions 400 × 400 mm
- Bowl depth 200 mm
- Pop-up drain system 3 ½"
- Cabinet size 600 mm



- Top mount Cod. **PR I 40**
- Flush mount Cod. **PR G 40**
- Under mount Cod. **PR O 40**

PRISMA 34

SOLO

- Material AISI 304
- Finishing Brushed
- Inner Corner R 0 mm Welded
- Overall dimensions 380 × 440 mm
- Basin dimensions 340 × 400 mm
- Bowl depth 200 mm
- Pop-up drain system 3 ½"
- Cabinet size 600 mm



- Top mount Cod. **PR I 34**
- Flush mount Cod. **PR G 34**
- Under mount Cod. **PR O 34**

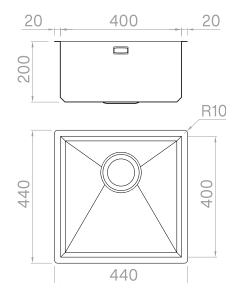

Accessories

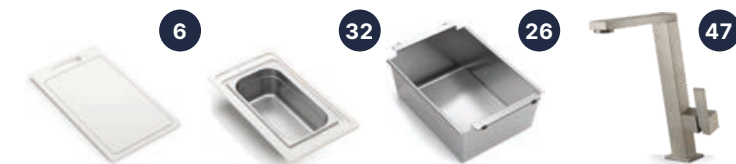

See p. 141 for all dedicated accessories.

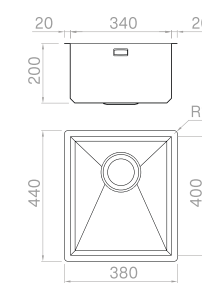

Accessories

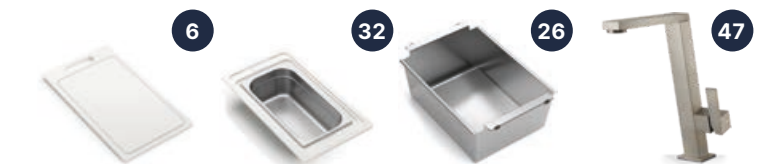

See p. 141 for all dedicated accessories.

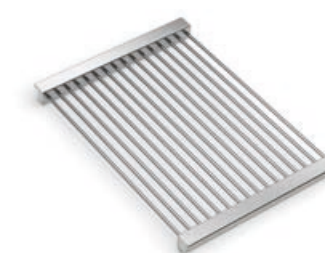
Wooden chopping board**3**300×420×20 mm
Cod. **TRIB 3042****HDPE chopping board****6**240×420×20 mm
Cod. **TRP 2442****Grid****12**250×420×25 mm
Cod. **GRS 2542****Colander****16**210×420×60 mm
Cod. **VQSF 2142****Slanted colander****23**280×420×110/60 mm
Cod. **VQSI 2842****Basin****26**280×420×160 mm
Cod. **VQSP 2842****Gastronorm set****30**240×420×100 mm
Cod. **TI 2442 V****Strainer set****32**240×420×100 mm
Cod. **TI 2442 1S****Slicer/grater set****34**200×420×20 mm
Cod. **TI 2442 PG****Plate holder****36**250×420×55 mm
Cod. **PPPB V400**

LINEA

The main feature of the collection lines is the edgless installing, egde and connections between sinks and countetops disappear.



LINEA 70

READY

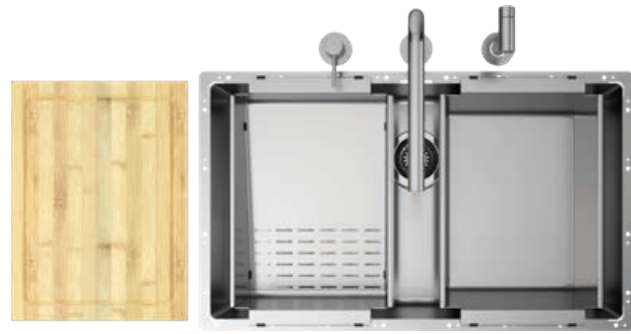

- Wooden chopping board
- Slanted colander
- Basin
- Element Tap

- 3
- 23
- 26
- 40

Edgeless

Cod. **SAL 70**

LINEA 70

PRO



- Colander

- 16

Edgeless

Cod. **SBL 70**

LINEA 70

SOLO



- | | |
|---------------------|----------------|
| Material | AISI 304 |
| Finishing | Brushed |
| Inner Corner | R 10 mm Welded |
| Overall dimensions | - |
| Basin dimensions | 700 × 400 mm |
| Bowl depth | 200 mm |
| Pop-up drain system | 3 ½" |
| Cabinet size | 800 mm |

Edgeless

Cod. **L 70**

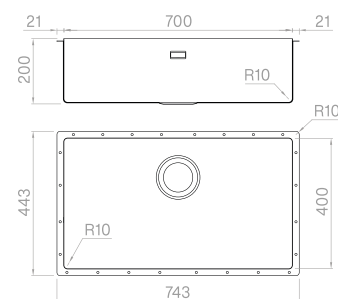

Accessories



See p. 151 for all dedicated accessories.

LINEA 65

READY

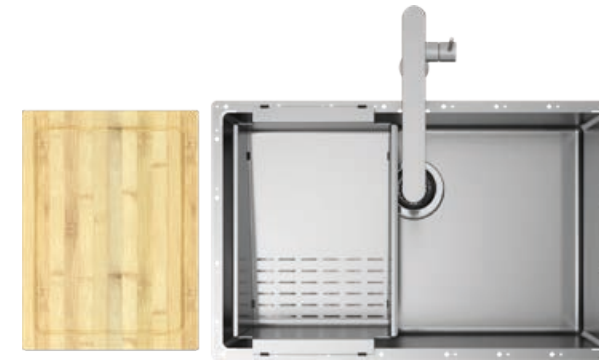

- Wooden chopping board
- Slanted colander
- Uber Tap

- 3
- 23
- 46

Edgeless

Cod. **SAL 65**

LINEA 65

PRO



- Colander

- 16

Edgeless

Cod. **SBL 65**

LINEA 65

SOLO



- | | |
|---------------------|----------------|
| Material | AISI 304 |
| Finishing | Brushed |
| Inner Corner | R 10 mm Welded |
| Overall dimensions | - |
| Basin dimensions | 650 × 400 mm |
| Bowl depth | 200 mm |
| Pop-up drain system | 3 ½" |
| Cabinet size | 750 mm |

Edgeless

Cod. **L 65**

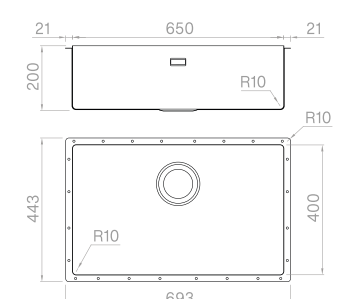

Accessories

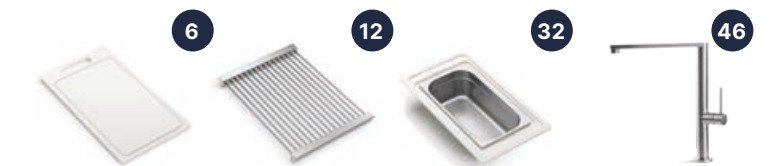

See p. 151 for all dedicated accessories.

LINEA 50

READY



- Wooden chopping board
- Slanted colander
- Uber Tap

- 3
- 23
- 46



Cod. **SAL 50**

LINEA 50

PRO



- Colander

- 16



Cod. **SBL 50**

LINEA 50

SOLO



- | | |
|---------------------|----------------|
| Material | AISI 304 |
| Finishing | Brushed |
| Inner Corner | R 10 mm Welded |
| Overall dimensions | - |
| Basin dimensions | 500 × 400 mm |
| Bowl depth | 200 mm |
| Pop-up drain system | 3 ½" |
| Cabinet size | 600 mm |



Cod. **L 50**

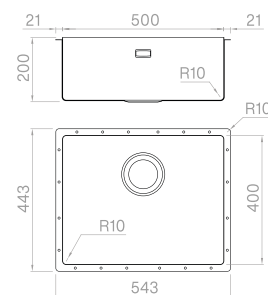

Accessories

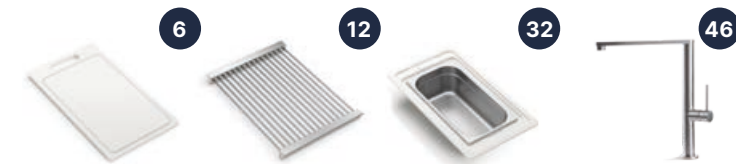

See p. 151 for all dedicated accessories.

LINEA 45

READY

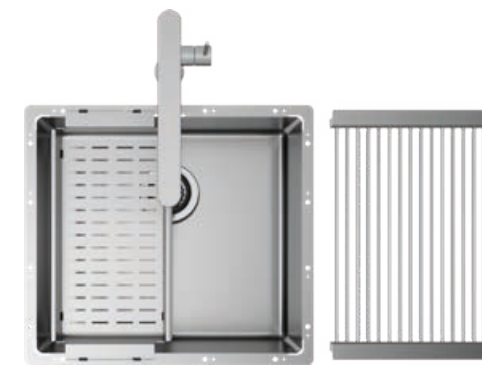

- Grid
- Colander
- Uber Tap

- 12
- 16
- 46



Cod. **SAL 45**

LINEA 45

PRO



- Colander

- 16



Cod. **SBL 45**

LINEA 45

SOLO



- | | |
|---------------------|----------------|
| Material | AISI 304 |
| Finishing | Brushed |
| Inner Corner | R 10 mm Welded |
| Overall dimensions | - |
| Basin dimensions | 450 × 400 mm |
| Bowl depth | 200 mm |
| Pop-up drain system | 3 ½" |
| Cabinet size | 600 mm |



Cod. **L 45**

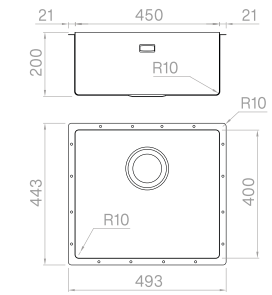

Accessories



See p. 151 for all dedicated accessories.

LINEA 40

READY

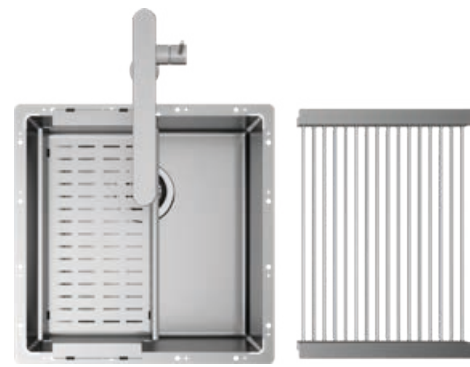

- Grid **12**
- Colander **16**
- Uber Tap **46**



Cod. **SAL 40**

LINEA 40

PRO



- Colander **16**



Cod. **SBL 40**

LINEA 40

SOLO



Material	AISI 304
Finishing	Brushed
Inner Corner	R 10 mm Welded
Overall dimensions	-
Basin dimensions	400 × 400 mm
Bowl depth	200 mm
Pop-up drain system	3 ½"
Cabinet size	600 mm



Cod. **L 40**

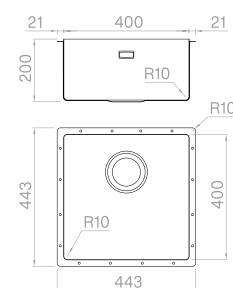

Accessories



See p. 151 for all dedicated accessories.

LINEA 34

READY

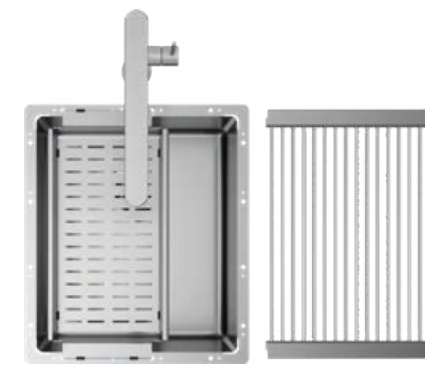

- Grid **12**
- Colander **16**
- Uber Tap **46**



Cod. **SAL 34**

LINEA 34

PRO



- Colander **16**



Cod. **SBL 34**

LINEA 34

SOLO



Material	AISI 304
Finishing	Brushed
Inner Corner	R 10 mm Welded
Overall dimensions	-
Basin dimensions	340 × 400 mm
Bowl depth	200 mm
Pop-up drain system	3 ½"
Cabinet size	600 mm



Cod. **L 34**

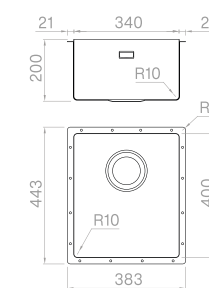

Accessories

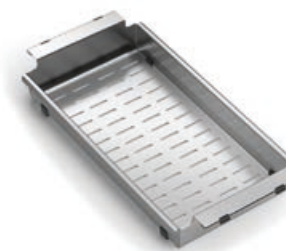

See p. 151 for all dedicated accessories.

Wooden chopping board**3**300×420×20 mm
Cod. **TRIB 3042****HDPE chopping board****6**240×420×20 mm
Cod. **TRP 2442****Grid****12**250×420×25 mm
Cod. **GRS 2542****Colander****16**210×420×60 mm
Cod. **VQSF 2142****Slanted colander****23**280×420×110/60 mm
Cod. **VQSI 2842****Basin****26**280×420×160 mm
Cod. **VQSP 2842****Gastronorm set****30**240×420×100 mm
Cod. **TI 2442 V****Strainer set****32**240×420×20 mm
Cod. **TI 2442 1S****Slicer/grater set****34**200×420×20 mm
Cod. **TI 2442 PG****Plate holder****36**250×420×55 mm
Cod. **PPPB V400**

ARTINOX

SHORE

Shore presents the innovative installation with walls in continuity to the worktop and the exposed stainless steel bottom with an exclusive perimeter tilted to 45°.



SHORE 70

READY



- Wooden chopping board
- Slanted colander
- Element Tap

- 3
- 23
- 40

Integrated

Cod. **SASH 70**

SHORE 65

READY



- Wooden chopping board
- Slanted colander
- Element Tap

- 3
- 23
- 40

Integrated

Cod. **SASH 65**

SHORE 70

PRO



Colander

16

Integrated

Cod. **SBSH 70**

SHORE 65

PRO



Colander

16

Integrated

Cod. **SBSH 65**

SHORE 70

SOLO



- | | |
|---------------------|---------------|
| Material | AISI 304 |
| Finishing | Brushed |
| Inner Corner | R 0 mm Welded |
| Overall dimensions | 766 × 466 mm |
| Basin dimensions | 700 × 400 mm |
| Bowl depth | 175 mm |
| Pop-up drain system | 3 ½" |
| Cabinet size | 800 mm |

Integrated

Cod. **SH 70**

SHORE 65

SOLO



- | | |
|---------------------|---------------|
| Material | AISI 304 |
| Finishing | Brushed |
| Inner Corner | R 0 mm Welded |
| Overall dimensions | 716 × 466 mm |
| Basin dimensions | 650 × 400 mm |
| Bowl depth | 175 mm |
| Pop-up drain system | 3 ½" |
| Cabinet size | 750 mm |

Integrated

Cod. **SH 65**

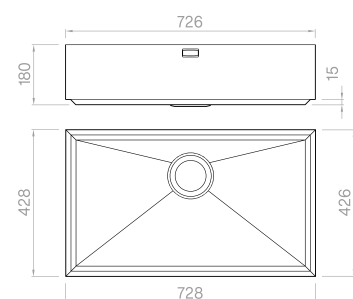

Accessories

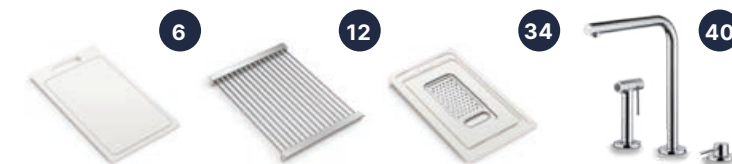

See p. 161 for all dedicated accessories.

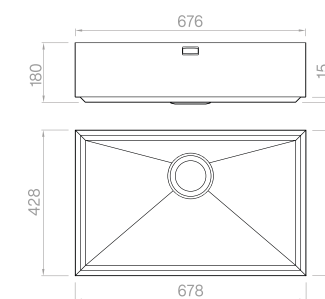

Accessories

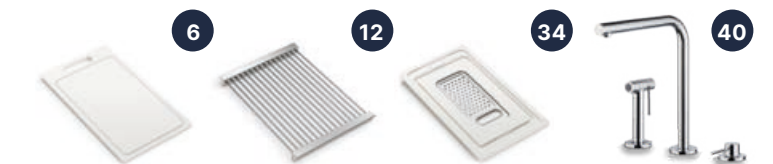

See p. 161 for all dedicated accessories.

SHORE 50

READY



- Wooden chopping board
- Slanted colander
- Element Tap

3
23
40

Integrated

Cod. **SASH 50**

SHORE 50

PRO



- Colander

16

Integrated

Cod. **SBSH 50**

SHORE 50

SOLO



- | | |
|---------------------|---------------|
| Material | AISI 304 |
| Finishing | Brushed |
| Inner Corner | R 0 mm Welded |
| Overall dimensions | 566 × 466 mm |
| Basin dimensions | 500 × 400 mm |
| Bowl depth | 175 mm |
| Pop-up drain system | 3 ½" |
| Cabinet size | 600 mm |

Integrated

Cod. **SH 50**

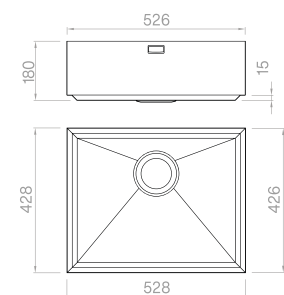

Accessories

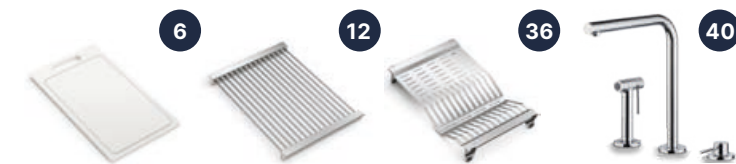

See p. 161 for all dedicated accessories.

SHORE 45

READY



- Grid
- Colander
- Uber Tap

12
16
46

Integrated

Cod. **SASH 45**

SHORE 45

PRO



- Colander

16

Integrated

Cod. **SBSH 45**

SHORE 45

SOLO



- | | |
|---------------------|---------------|
| Material | AISI 304 |
| Finishing | Brushed |
| Inner Corner | R 0 mm Welded |
| Overall dimensions | 516 × 466 mm |
| Basin dimensions | 450 × 400 mm |
| Bowl depth | 175 mm |
| Pop-up drain system | 3 ½" |
| Cabinet size | 600 mm |

Integrated

Cod. **SH 45**

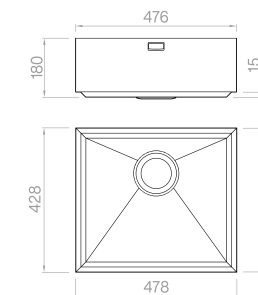

Accessories

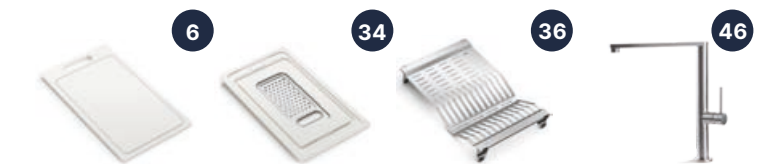

See p. 161 for all dedicated accessories.

SHORE 40 + 34

READY

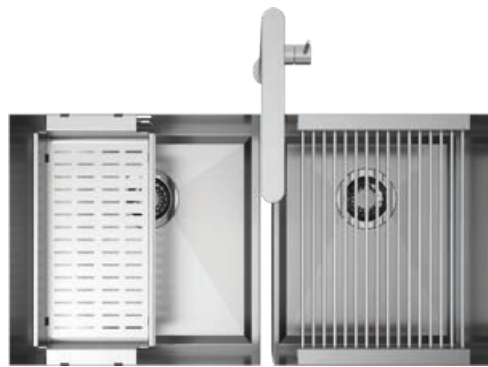

Grid
Colander
Uber Tap

12
16
46

Integrated

Cod. **SASH 40**

SHORE 34 + 34

READY

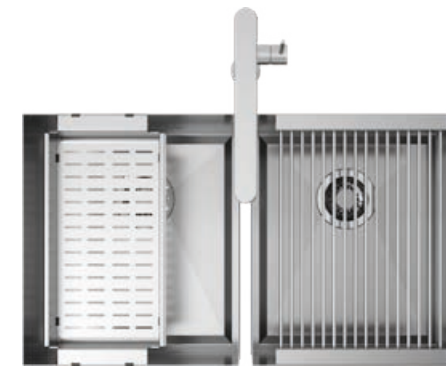

Grid
Colander
Uber Tap

12
16
46

Integrated

Cod. **SASH 34**

SHORE 40

PRO



Colander

16

Integrated

Cod. **SBSH 40**

SHORE 34

PRO



Colander

16

Integrated

Cod. **SBSH 34**

SHORE 40

SOLO



Material	AISI 304
Finishing	Brushed
Inner Corner	R 0 mm Welded
Overall dimensions	466 × 466 mm
Basin dimensions	400 × 400 mm
Bowl depth	175 mm
Pop-up drain system	3 ½"
Cabinet size	600 mm

Integrated

Cod. **SH 40**

SHORE 34

SOLO



Material	AISI 304
Finishing	Brushed
Inner Corner	R 0 mm Welded
Overall dimensions	406 × 466 mm
Basin dimensions	340 × 400 mm
Bowl depth	175 mm
Pop-up drain system	3 ½"
Cabinet size	600 mm

Integrated

Cod. **SH 34**

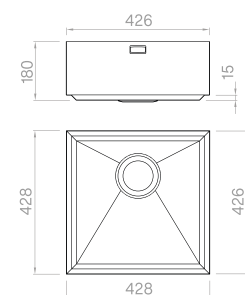

Accessories

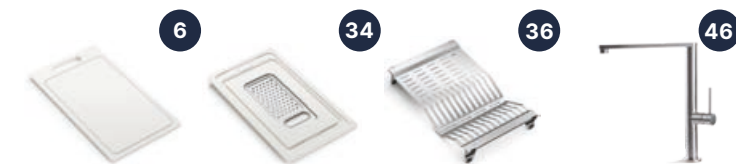

See p. 161 for all dedicated accessories.

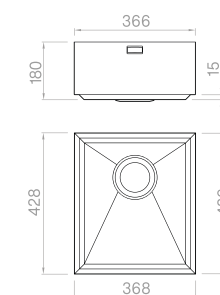

Accessories

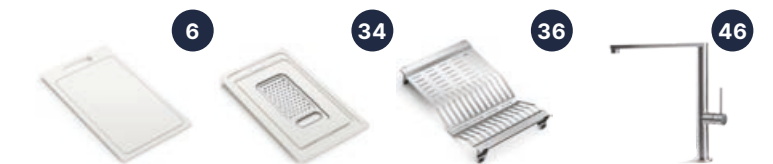

See p. 161 for all dedicated accessories.

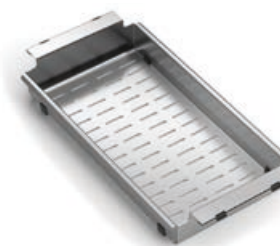
Wooden chopping board**3**300×420×20 mm
Cod. **TRIB 3042****HDPE chopping board****6**240×420×20 mm
Cod. **TRP 2442****Grid****12**250×420×25 mm
Cod. **GRS 2542****Colander****16**210×420×60 mm
Cod. **VQSF 2142****Slanted colander****23**280×420×110/60 mm
Cod. **VQSI 2842****Basin****26**280×420×160 mm
Cod. **VQSP 2842****Gastronorm set****30**240×420×100 mm
Cod. **TI 2442 V****Strainer set****32**240×420×100 mm
Cod. **TI 2442 1S****Slicer/grater set****34**200×420×20 mm
Cod. **TI 2442 PG****Plate holder****36**250×420×55 mm
Cod. **PPPB V400**

SINK MIXERS

Artinox mixers are manufactured by Italian partners. They are available in all Artinox finishings to be combined with monochromatic solutions with a very high aesthetic impact.



ATHOM GUN METAL

42

Finishing	PVD gun metal
Swivel angle	180°
Installation hole	Ø 35 mm
Cartridge	ceramic disc
Spray	extractable

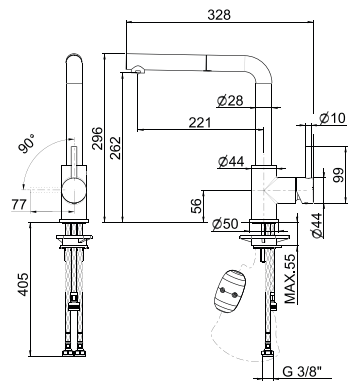
Cod. **SS 02721**

ATHOM COPPER BRONZE

43

Finishing	PVD copper bronze
Swivel angle	180°
Installation hole	Ø 35 mm
Cartridge	ceramic disc
Spray	extractable

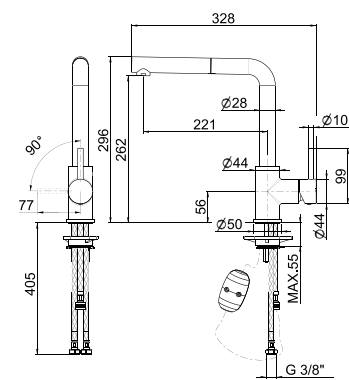
Cod. **SS 02722**

ATHOM PALE GOLD

44

Finishing	PVD pale gold
Swivel angle	180°
Installation hole	Ø 35 mm
Cartridge	ceramic disc
Spray	extractable

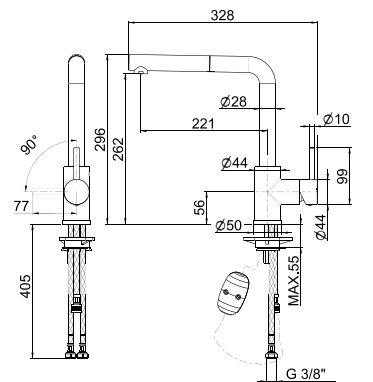
Cod. **SS 02723**

CIRCLE

45

Finishing	Inox Brushed
Swivel angle	360°
Installation hole	Ø 35 mm
Cartridge	ceramic disc
Spray	extractable

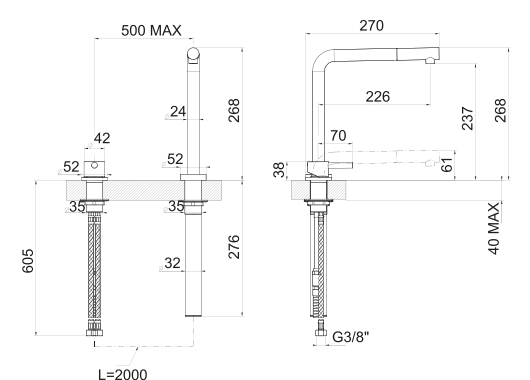
Cod. **SS 02700**

UBER

46

Material	Stainless steel AISI 304
Finishing	Brushed
Swivel angle	360°
Installation hole	Ø 35 mm
Cartridge	ceramic disc

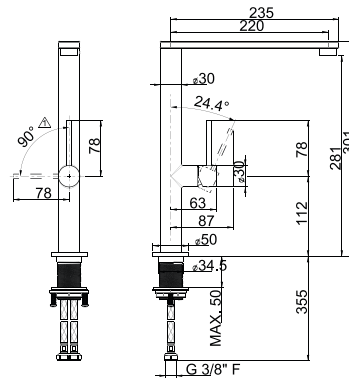

Cod. **SS 02720**

VERTIGO

47

Finishing	Inox Brushed
Swivel angle	360°
Installation hole	Ø 35 mm
Cartridge	ceramic disc

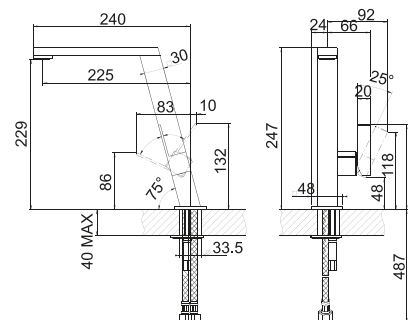

Cod. **SS 01164**



COMPLEMENTS

STRAINERS AND OVERFLOWS



**PLUS –
BRUSHED**

Cod. **SS 02608**



**STANDARD –
BRUSHED**

Cod. **SS 02740**



**BLACK –
MATTE BLACK**

Cod. **SS 02741**



**ECLISSE –
BRUSHED**

It allows the outflow.
3 ½" strainer compatible.

Cod. **SS 02748**

STRAINERS AND OVERFLOWS – TITANIUM



**PLUS –
GUN METAL**

Cod. **SS 02717**

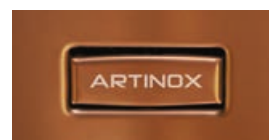

**PLUS –
COPPER BRONZE**

Cod. **SS 02716**



**PLUS –
PALE GOLD**

Cod. **SS 02715**

AUTOMATIC DRAIN SYSTEMS



POP-UP – PLUS

Pressure actuation.

Cod. **SS 02744**



POP-UP – STANDARD

Pressure actuation.

Cod. **SS 02742**



POP-UP – BLACK

Pressure actuation.

Cod. **SS 02743**



AUTOMATIC DRAIN SYSTEMS – TITANIUM



POP-UP – PLUS

Gun Metal – Pressure actuation.

Cod. **SS 02747**



POP-UP – PLUS

Copper Bronze – Pressure actuation.

Cod. **SS 02746**



POP-UP – PLUS

Pale Gold – Pressure actuation.

Cod. **SS 02745**



'U' TRAPS



Space-saving self-cleaning 'U' trap drainage outlet for single or double drain sinks; dishwasher attachment included.

Cod. **1 way** **SS 00448**
Cod. **2 ways** **SS 00449**

FOOD WASTE DISPOSER



Brushed steel – It allows the outflow.
3 ½" strainer compatible.
Titanium and Matte Vintage not available.

Cod. **TRFWD 60T**

STAINLESS STEEL CARE



CLEANING - COMPLETE KIT

- Cleansing cream (250 ml bottle)
- Cleaning cloth
- Finishing cloth

Cod. **SS 01751**
Cod. **SS 02771** (12 Pks.)

CLEANSING CREAM

Specific for stainless steel.

Cod. **SS 02790**
Cod. **SS 02772** (12 Pcs.)



ANTIBACTERIAL CLOTH

Microfiber for finishing.
Size 40×40 cm – pack of 3 pieces.

Cod. **SS 02773**
Cod. **SS 02774** (12 Pks.)

ARTINOX workstation sinks are made of AISI 304 18/10 (EN 1.4301) stainless steel, a chromium-nickel steel alloy. Stainless steel is the hygienic material par excellence, tough and very resistant to corrosion, the ideal product for contact with food. All ARTINOX items are made in compliance with the strictest quality standards and tested one by one.

WARNINGS

Like all materials, stainless steel also requires regular care and daily cleaning. Improper use can damage the surface even permanently. The following recommendations protect the sink from corrosion damage caused by unsuitable cleaning agents.

CLEANING

For daily cleaning, we recommend squeezing a sponge out of hot water and dipping it in white vinegar. For deep cleaning, use ONLY official Artinox products, which can be purchased from authorized dealers or by consulting www.artinox.com.

MAINTENANCE

After each use, clean, rinse and dry the sink thoroughly with a soft cloth.
DO NOT leave detergents and cleaning products in contact with the surface for a long time.
DO NOT use hydrochloric acid, hydrofluoric acid, phosphoric acid, bleach, ammonia, or detergents that contain even small doses of these substances.
DO NOT use abrasive sponges, detergents and creams.
DO NOT leave objects, ferrous and non-ferrous metals inside the sink

GENERAL SELLING CONDITIONS

How to order:

We accept only written and complete orders. The order must indicate codes, as written in this price-list. Confirmation of order will follow, by fax and/or mail, and it is considered accepted if not contested within 3 days. The company Artinox spa reserves the right to change and/or cancel, if necessary, products, dimensions, descriptions and prices shown in this price list without notice and without any possibility for the customer to claim.

Delivery:

The delivery times are approximate and in reference to normal working conditions. In no case shall the seller be asked for reimbursement for any damages due to delayed delivery, nor shall the delay constitute a reason for cancellation of the contract. Quality and type of goods must be checked by the buyer at delivery.

Delivery terms:

Exw Conegliano (Treviso) Italy. Goods travel at the consignee's risk, even in case of free of charge delivery.

Packing:

Standard packing in cardboard boxes included in price. Special packing shall be charged at cost.

Prices:

The prices shown in this price list are exclusive of: vat, carriage, special packing, customs duties, wooden crates and/or pallets, assembly and final test and inspection.

Terms of payment:

To be agreed. All charges related to payment of bank commissions, stamp duties, etc. Shall be debited on the invoice. In the event of delayed payments, the company reserves the right to suspend delivery of the orders on hand, without obligation to give notice. The parties agree that the buyer will get the ownership of the material after payment of the total price, Accessories included, but he will take the risks after delivery of the goods (ex art. 1523 c.c. Italian law). After the payment terms agreed by the two parties have fallen due, no complaint relating the quality of the goods can be made, unless regular payment of the goods has been effected.

Default interest:

Any delay in payments automatically leads to the charging of default interest at a rate of 1,5 % a month from the expiry date which is indicated in the invoice. Any charges borne to recover due amounts are for the buyer's account.

Warranty:

The warranty period is 24 months from the date of dispatch and covers every single part. The seller is not responsible for direct and/or indirect damages caused by and/or to equipments, plants, people for improper use, for bumps, wrong installation, for use out of tolerance.

Please give immediately notice of surface flaws such as blows, scratches, stains or breakages before installing or using any product. Any defect pointed out after the installation, as not attributable to fabrication flaws, will be excluded from the warranty.

Faulty parts are to be delivered ex our works (Conegliano Treviso - Italy) and will be replaced under guarantee only after through check. The recognized faulty parts will be replaced and mailed or sent free of charge by carrier. The guarantee does not cover the charges of replacement of parts, it is not transferable and complete replacement of parts or appliance is at the final discretion of the manufacturer.

Each product in this catalog is manufactured in compliance to current regulations and CE directives.

All data shown are not binding.

Artinox S.p.a. reserves the right to make changes deemed useful for the improvement of its offer at any time, without notice and disclaiming any responsibility for errors or inaccuracies.

The reproduction of the colors in the catalog are to be considered indicative. Reproductions of all or part of this catalog are prohibited without the specific written authorization of Artinox S.p.a.

© Copyright 2023 Artinox S.p.a. - All rights reserved.

Ed. 2 - May 2023

Artinox S.p.a. certifications:



Artinox SpA

Via F. Fabbri, 39

z.i. Campidui

31015 Conegliano (TV)

+39 0438 4531

domestic@artinox.com

artinox-sinks.com

