

ARTINOX

WORKSTATION SINKS

UNSER EDELSTAHL

Unser Edelstahl wird sowohl im privaten als auch im professionellen Bereich eingesetzt und erfüllt alle Industriestandards. Dank der porenfreien Oberfläche ist es äußerst leicht zu reinigen, was zu einer hohen antibakteriellen Wirkung führt. Unser Stahl ist im Laufe der Zeit unveränderlich, besteht zu über 70 % aus recycelten Materialien und ist zu 100 % recycelbar.

ARBEITSSTATION INNOVATIVES DESIGN

Bei Artinox revolutionieren wir die in der Küche verbrachte Zeit. Alle Arbeitsplätze sind in die Arbeitsplatte integriert und bilden eine Einheit. Das Schiebeseite ermöglicht die Positionierung und das Verschieben unzähliger Zubehörteile für mehrere Funktionen; Von Gittern bis zu Stützen, von Schneidebrettern bis zu Behältern sind diese Accessoires auf Langlebigkeit ausgelegt und lassen sich mit einer einfachen Geste servieren.



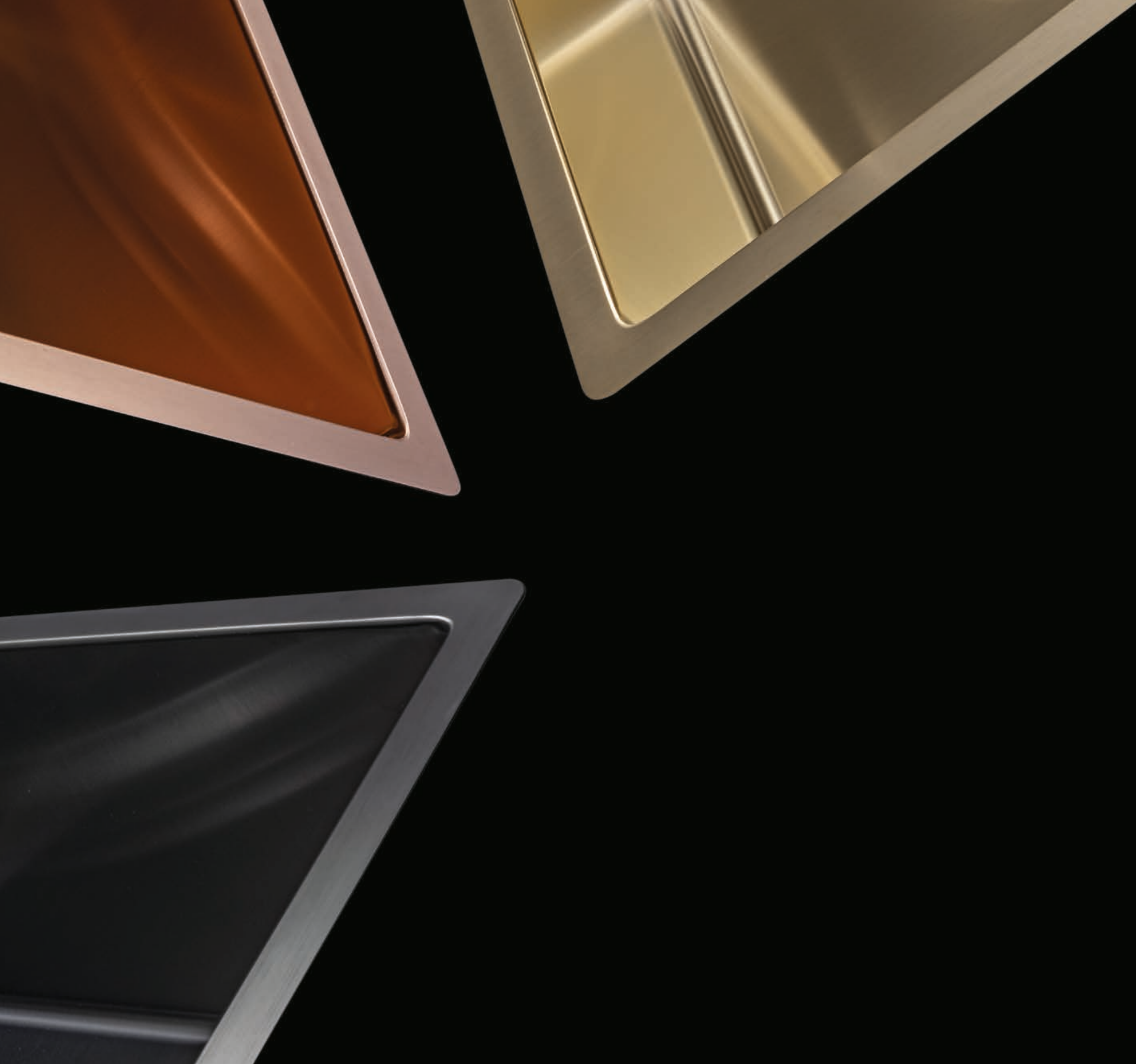

TITANIUM

Das PVD ist eine ungiftige Technologie, mit der Sie von Edelstahl auf Farbe wechseln können.

Die drei exklusiven Ausführungen Gun Metal, Kupferbronze und Hellgold werden auf monochromatische Lösungen mit sehr hoher ästhetischer Wirkung aufgetragen.

TITANIUM COPPER BRONZE



TITANIUM 70 COPPER BRONZE



READY

Colander Copper Bronze
Athom Tap

18

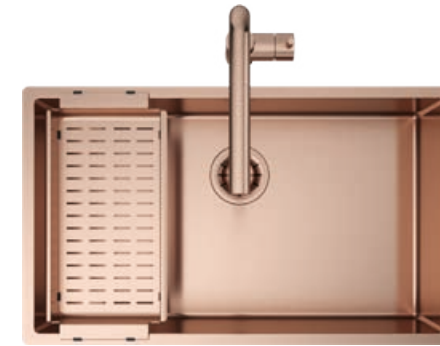
43



-  Top mount
-  Flush mount
-  Under mount

Cod. **SAT I 70 RC**
Cod. **SATG 70 RC**
Cod. **SATO 70 RC**



TITANIUM 70 COPPER BRONZE

PRO

Colander Copper Bronze

18



-  Top mount
-  Flush mount
-  Under mount



Cod. **SBT I 70 RC**
Cod. **SBTG 70 RC**
Cod. **SBTO 70 RC**

TITANIUM 70 COPPER BRONZE

SOLO

Material	AISI 304
Finishing	PVD Copper Bronze
Inner Corner	R 10 mm Welded
Overall dimensions	740 × 440 mm
Basin dimensions	700 × 400 mm
Bowl depth	200 mm
Plus Strainer Copper Bronze	3 ½"
Cabinet size	800 mm



-  Top mount
-  Flush mount
-  Under mount

Cod. **TI 7040 RC**
Cod. **TG 7040 RC**
Cod. **TO 7040 RC**

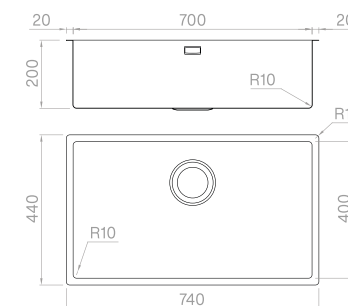

Accessories



See p. 91 for all dedicated accessories.

TITANIUM 50 COPPER BRONZE

READY



Colander Copper Bronze
Athom Tap

18
43

- Top mount
- Flush mount
- Under mount

Cod. **SAT I 50 RC**
Cod. **SATG 50 RC**
Cod. **SATO 50 RC**

TITANIUM 40 COPPER BRONZE

READY



Colander Copper Bronze
Athom Tap

18
43

- Top mount
- Flush mount
- Under mount

Cod. **SAT I 40 RC**
Cod. **SATG 40 RC**
Cod. **SATO 40 RC**

TITANIUM 50 COPPER BRONZE

PRO



Colander Copper Bronze

18

- Top mount
- Flush mount
- Under mount

Cod. **SBT I 50 RC**
Cod. **SBTG 50 RC**
Cod. **SBTO 50 RC**

TITANIUM 40 COPPER BRONZE

PRO



Colander Copper Bronze

18

- Top mount
- Flush mount
- Under mount

Cod. **SBT I 40 RC**
Cod. **SBTG 40 RC**
Cod. **SBTO 40 RC**

TITANIUM 50 COPPER BRONZE

SOLO



Material	AISI 304
Finishing	PVD Copper Bronze
Inner Corner	R 10 mm Welded
Overall dimensions	540 × 440 mm
Basin dimensions	500 × 400 mm
Bowl depth	200 mm
Plus Strainer Copper Bronze	3 ½"
Cabinet size	600 mm

- Top mount
- Flush mount
- Under mount

Cod. **TI 5040 RC**
Cod. **TG 5040 RC**
Cod. **TO 5040 RC**

TITANIUM 40 COPPER BRONZE

SOLO

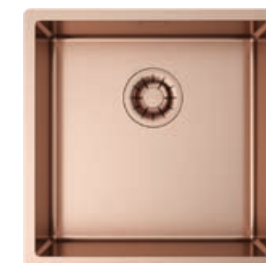

Material	AISI 304
Finishing	PVD Copper Bronze
Inner Corner	R 10 mm Welded
Overall dimensions	440 × 440 mm
Basin dimensions	400 × 400 mm
Bowl depth	200 mm
Plus Strainer Copper Bronze	3 ½"
Cabinet size	600 mm

- Top mount
- Flush mount
- Under mount

Cod. **TI 4040 RC**
Cod. **TG 4040 RC**
Cod. **TO 4040 RC**

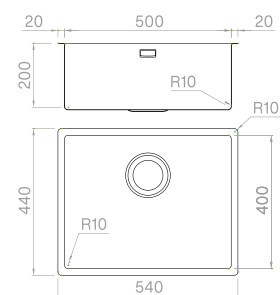

Accessories



See p. 91 for all dedicated accessories.

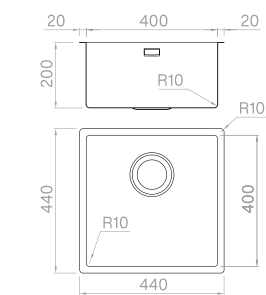

Accessories



See p. 91 for all dedicated accessories.

TITANIUM PALE GOLD







TITANIUM 70 PALE GOLD

READY

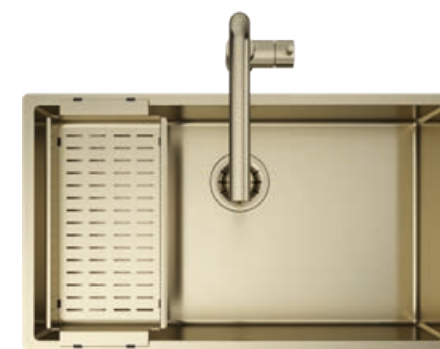
Colander Pale Gold
Athom Tap

19
44



-  Top mount
-  Flush mount
-  Under mount

Cod. **SAT I 70 RG**
Cod. **SATG 70 RG**
Cod. **SATO 70 RG**



TITANIUM 70 PALE GOLD

PRO

Colander Pale Gold

19



-  Top mount
-  Flush mount
-  Under mount



Cod. **SBT I 70 RG**
Cod. **SBTG 70 RG**
Cod. **SBTO 70 RG**

TITANIUM 70 PALE GOLD

SOLO

Material	AISI 304
Finishing	PVD Pale Gold
Inner Corner	R 10 mm Welded
Overall dimensions	740 × 440 mm
Basin dimensions	700 × 400 mm
Bowl depth	200 mm
Plus Strainer Pale Gold	3 1/2"
Cabinet size	800 mm



-  Top mount
-  Flush mount
-  Under mount

Cod. **TI 7040 RG**
Cod. **TG 7040 RG**
Cod. **TO 7040 RG**

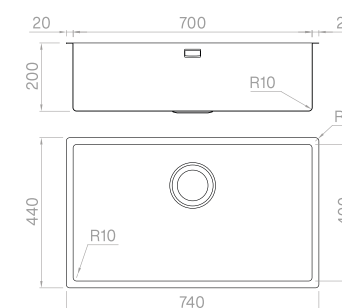

Accessories



See p. 91 for all dedicated accessories.

TITANIUM 50 PALE GOLD

READY

Colander Pale Gold
Athom Tap

19
44



- Top mount
- Flush mount
- Under mount

Cod. **SAT I 50 RG**
Cod. **SATG 50 RG**
Cod. **SATO 50 RG**

TITANIUM 40 PALE GOLD

READY

Colander Pale Gold
Athom Tap

19
44



- Top mount
- Flush mount
- Under mount

Cod. **SAT I 40 RG**
Cod. **SATG 40 RG**
Cod. **SATO 40 RG**

TITANIUM 50 PALE GOLD

PRO

Colander Pale Gold

19



- Top mount
- Flush mount
- Under mount

Cod. **SBT I 50 RG**
Cod. **SBTG 50 RG**
Cod. **SBTO 50 RG**

TITANIUM 40 PALE GOLD

PRO

Colander Pale Gold

19



- Top mount
- Flush mount
- Under mount

Cod. **SBT I 40 RG**
Cod. **SBTG 40 RG**
Cod. **SBTO 40 RG**

TITANIUM 50 PALE GOLD

SOLO

Material	AISI 304
Finishing	PVD Pale Gold
Inner Corner	R 10 mm Welded
Overall dimensions	540 × 440 mm
Basin dimensions	500 × 400 mm
Bowl depth	200 mm
Plus Strainer Pale Gold	3 ½"
Cabinet size	600 mm

- Top mount Cod. **TI 5040 RG**
- Flush mount Cod. **TG 5040 RG**
- Under mount Cod. **TO 5040 RG**



TITANIUM 40 PALE GOLD

SOLO

Material	AISI 304
Finishing	PVD Pale Gold
Inner Corner	R 10 mm Welded
Overall dimensions	440 × 440 mm
Basin dimensions	400 × 400 mm
Bowl depth	200 mm
Plus Strainer Pale Gold	3 ½"
Cabinet size	600 mm

- Top mount Cod. **TI 4040 RG**
- Flush mount Cod. **TG 4040 RG**
- Under mount Cod. **TO 4040 RG**

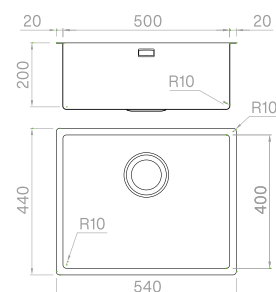
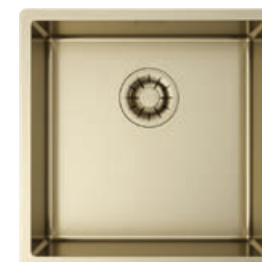

Accessories



See p. 91 for all dedicated accessories.

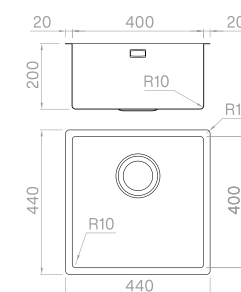

Accessories



See p. 91 for all dedicated accessories.

**Wooden chopping board****3**

300×420×20 mm
Cod. **TRIB 3042**

**HDPE chopping board****6**

240×420×20 mm
Cod. **TRP 2442**

**Colander Gun Metal****17**

210×420×60 mm
Cod. **VQAF 2142**

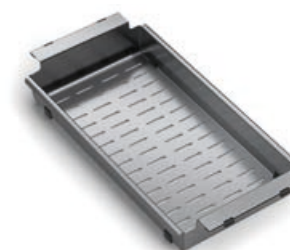
**Colander Copper Bronze****18**

210×420×60 mm
Cod. **VQCF 2142**

**Colander Pale Gold****19**

210×420×60 mm
Cod. **VQGF 2142**

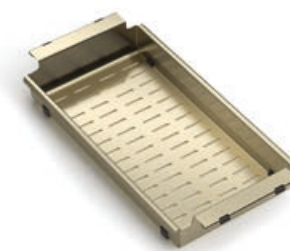
**Gastronorm set****30**

240×420×100 mm
Cod. **TI 2442 V**

**Strainer set****32**

240×420×100 mm
Cod. **TI 2442 1S**

**Slicer/grater set****34**

200×420×20 mm
Cod. **TI 2442 PG**



COMPLEMENTS

STRAINERS AND OVERFLOWS



**PLUS –
BRUSHED**

Cod. **SS 02608**



**PLUS –
GUN METAL**

Cod. **SS 02717**



**STANDARD –
BRUSHED**

Cod. **SS 02740**

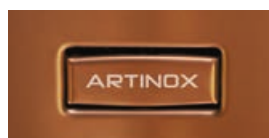

**PLUS –
COPPER BRONZE**

Cod. **SS 02716**



**BLACK –
MATTE BLACK**

Cod. **SS 02741**



**PLUS –
PALE GOLD**

Cod. **SS 02715**



**ECLISSE –
BRUSHED**

It allows the outflow.
3 1/2" strainer compatible.

Cod. **SS 02748**

STRAINERS AND OVERFLOWS – TITANIUM

AUTOMATIC DRAIN SYSTEMS

AUTOMATIC DRAIN SYSTEMS – TITANIUM



POP-UP – PLUS

Pressure actuation.

Cod. **SS 02744**



POP-UP – PLUS

Gun Metal – Pressure actuation.

Cod. **SS 02747**



POP-UP – STANDARD

Pressure actuation.

Cod. **SS 02742**



POP-UP – PLUS

Copper Bronze – Pressure actuation.

Cod. **SS 02746**



POP-UP – BLACK

Pressure actuation.

Cod. **SS 02743**



POP-UP – PLUS

Pale Gold – Pressure actuation.

Cod. **SS 02745**



'U' TRAPS



Platzsparender, selbstreinigender U-Siphon-Abfluss für Einzel- oder Doppelablaufbecken; Spülmaschinenaufsatz im Lieferumfang enthalten.

Cod. **1 way** **SS 00448**
Cod. **2 ways** **SS 00449**

FOOD WASTE DISPOSER



Brushed steel – It allows the outflow.
3 ½" strainer compatible.
Titanium and Matte Vintage not available.

Cod. **TRFWD 60T**

STAINLESS STEEL CARE



CLEANING - COMPLETE KIT

- Cleansing cream (250 ml bottle)
- Cleaning cloth
- Finishing cloth

Cod. **SS 01751**
Cod. **SS 02771** (12 Pks.)

CLEANSING CREAM

Specific for stainless steel.

Cod. **SS 02790**
Cod. **SS 02772** (12 Pcs.)



ANTIBACTERIAL CLOTH

Microfiber for finishing.
Size 40×40 cm – pack of 3 pieces.

Cod. **SS 02773**
Cod. **SS 02774** (12 Pks.)

ARTINOX-Arbeitsplatzspülen bestehen aus Edelstahl AISI 304 18/10 (EN 1.4301), einer Chrom-Nickel-Stahllegierung. Edelstahl ist das hygienische Material schlechthin, robust und sehr korrosionsbeständig, das ideale Produkt für den Kontakt mit Lebensmitteln. Alle ARTINOX-Artikel werden unter Einhaltung strengster Qualitätsstandards hergestellt und einzeln geprüft.

WARNHINWEISE

Wie alle Materialien bedarf auch Edelstahl einer regelmäßigen Pflege und täglichen Reinigung. Bei unsachgemäßer Anwendung kann die Oberfläche sogar dauerhaft beschädigt werden. Die folgenden Empfehlungen schützen die Spüle vor Korrosionsschäden durch ungeeignete Reinigungsmittel.

REINIGUNG

Für die tägliche Reinigung empfehlen wir, einen Schwamm aus heißem Wasser auszudrücken und ihn in weißem Essig zu tauchen. Verwenden Sie für die Tiefenreinigung NUR offizielle Artinox-Produkte, die Sie bei autorisierten Händlern oder unter www.artinox.com erwerben können.

WARTUNG

Reinigen, spülen und trocknen Sie das Waschbecken nach jedem Gebrauch gründlich mit einem weichen Tuch.

Lassen Sie Wasch- und Reinigungsmittel NICHT über längere Zeit mit der Oberfläche in Kontakt.

Verwenden Sie KEINE Salzsäure, Flusssäure, Phosphorsäure, Bleichmittel, Ammoniak oder Reinigungsmittel, die auch nur geringe Dosen dieser Substanzen enthalten.

Verwenden Sie KEINE Scheuerschwämme, Reinigungsmittel und Cremes.

Lassen Sie KEINE Gegenstände, Eisen- und Nichteisenmetalle im Spülbecken zurück

