

FOLD

by Tord Boontje

Obsessed with Details — 2026 Collection

FOLD

by Tord Boontje

One single element

Our FOLD collection by Tord Boontje differs fundamentally from traditional models in the way it innovatively blends the classic components of a door fitting — rosette, neck, and handle — into one single element. This is achieved thanks to an astute system with mounting akin to a bayonet system. The result is a door handle that appears to float elegantly on the door.

Onze FOLD collectie by Tord Boontje onderscheidt zich van traditionele modellen door de innovatieve manier waarop de klassieke componenten van een deurkruk — rozet, hals en greep — in één enkel element zijn samengevoegd. Door een slim systeem, dat in de montage vergelijkbaar is met een bajonetsysteem, zweeft de deurkruk als het ware sierlijk op de deur.



reddot design award

FOLD / 531



by Tord Boontje

“I’m interested in creating elements for everyday life that are exciting and uplifting to live with. Explore and use accessories to re-invent your space.”

London, United Kingdom

Design philosophy:
“A design is not just a design, it should tell a story.”

Designed for FORMANI:
FOLD

Design award:
Red Dot Design Award

Photography:
Angela Moore



FOLD TB100
satin stainless steel

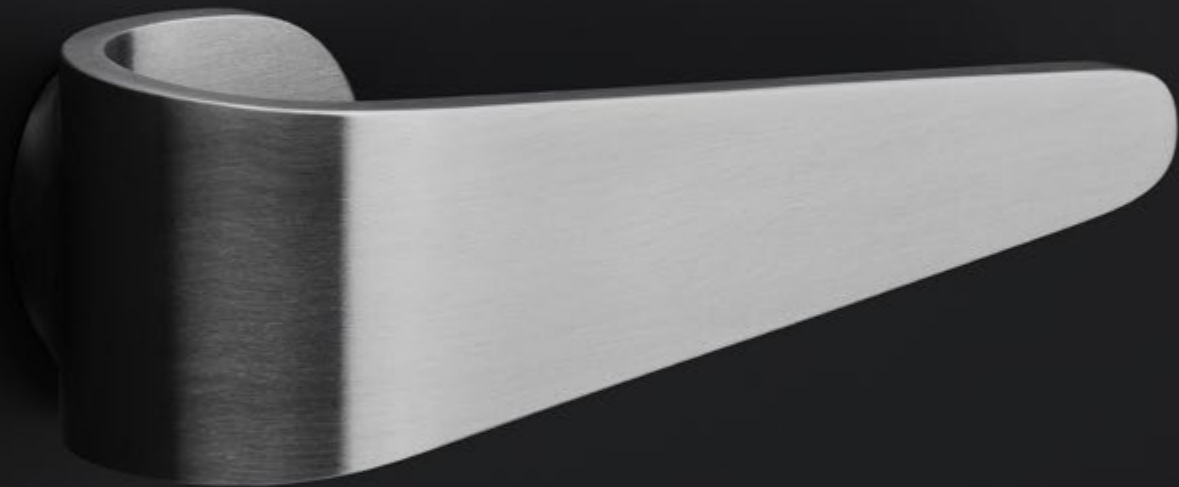

FOLD

Total concept

Door fittings

Lever handles
Lever handle accessories

Front door fittings

Front door knobs
Pull handle

Accessories

Cabinet handles
Cabinet knobs
Sliding door handles

Deurbeslag

Deurkrukken
Accessoires deurkrukken

Voordeurbeslag

Voordeurknoppen
Grepes

Accessoires

Meubelgrepen
Meubelknoppen
Hefschuifdeurbeslag

550

550

550

551

551

551

551

551

551

552

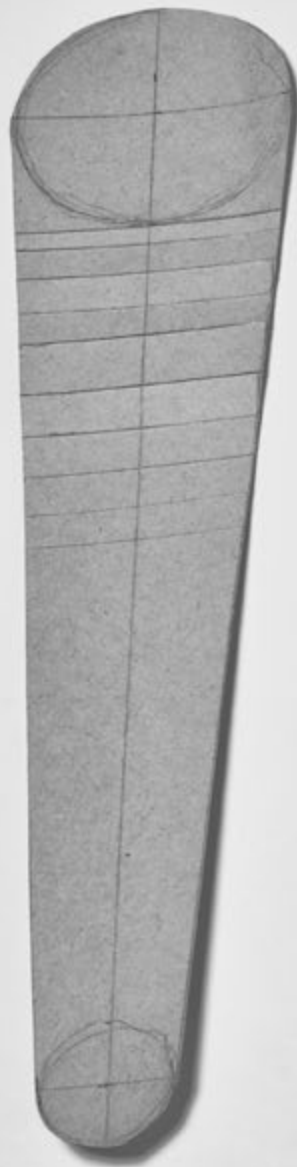
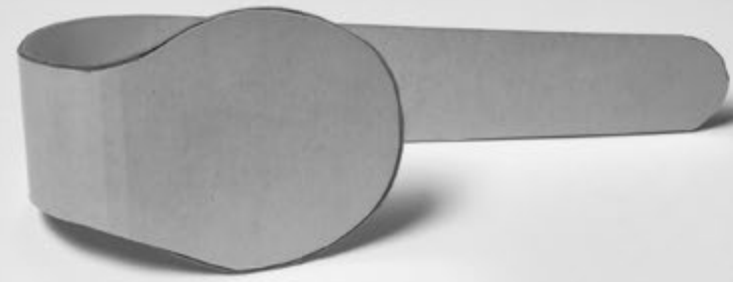

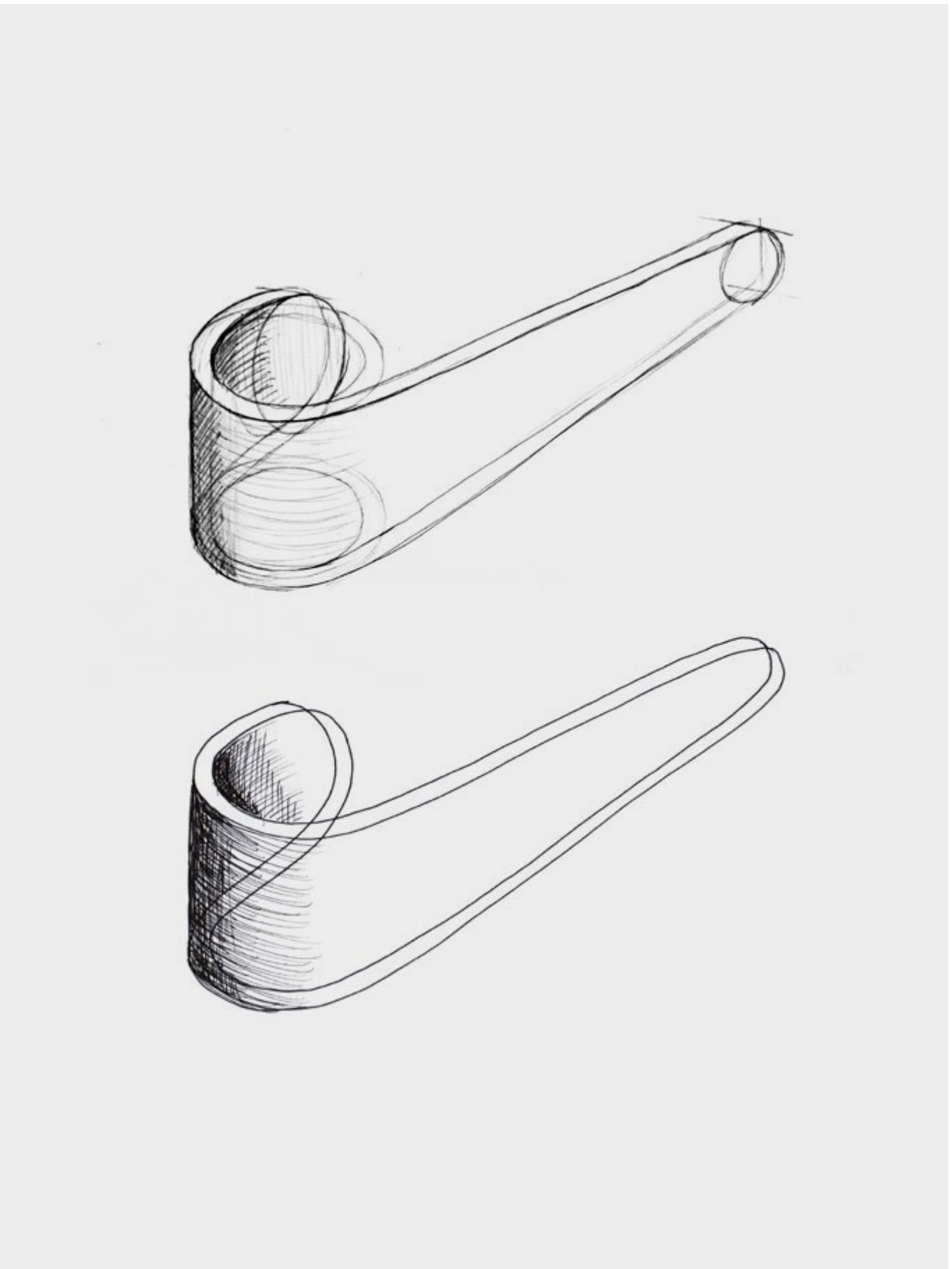
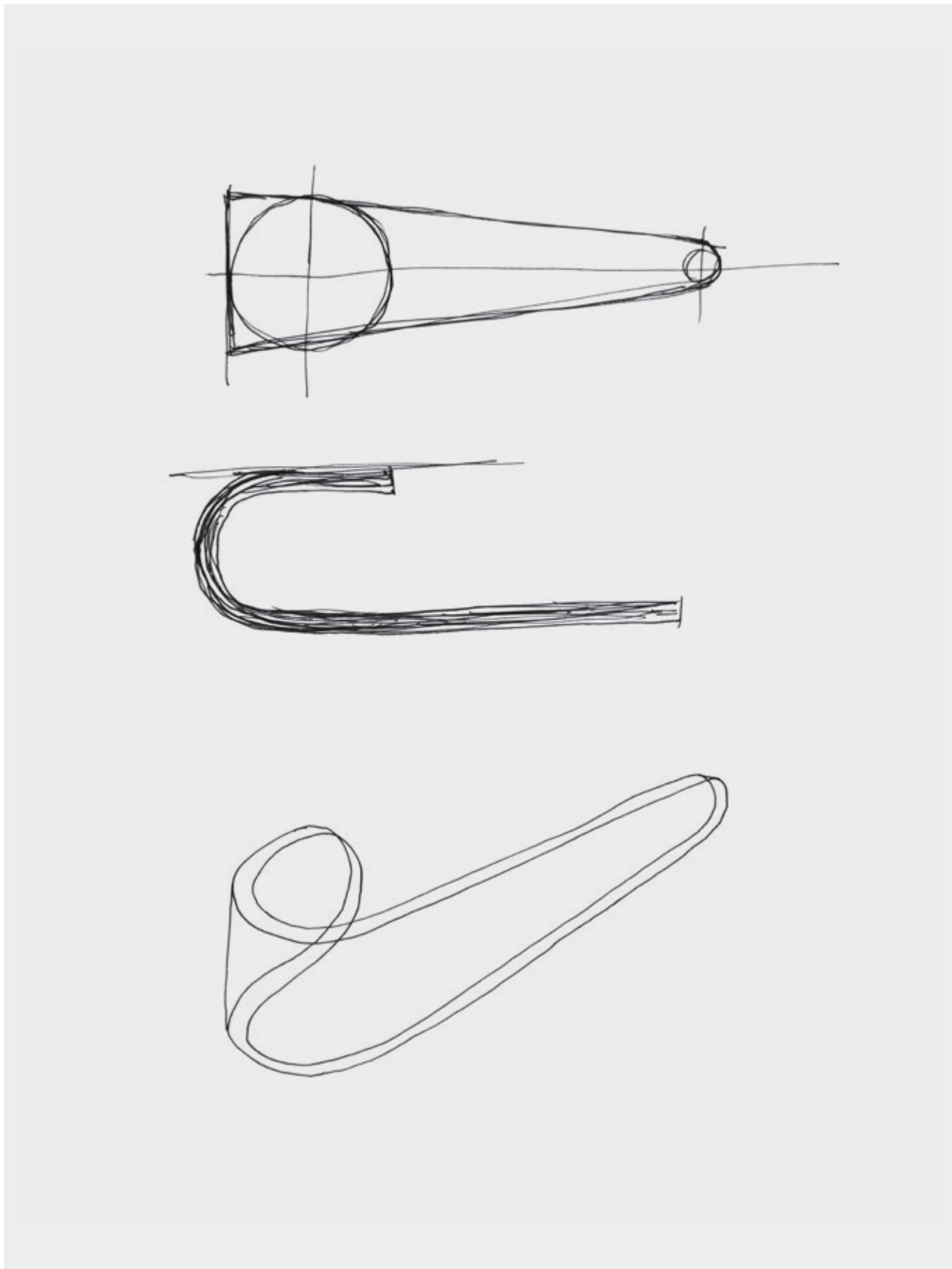



In detail

Rosette-less construction

With FOLD, the traditional distinction between handle and rosette is eliminated. The construction is conceived as a single seamless design element, mounted using a bayonet system that is known for its precision and reliability.

Exact centring and minimal visible components result in a calm appearance. All technical elements are invisibly integrated, allowing form and function to align naturally.

Bij FOLD verdwijnt het traditionele onderscheid tussen kruk en rozet. De constructie is opgevat als één naadloos geheel dat met een bajonet-systeem op de deur wordt bevestigd, een techniek die bekendstaat om zijn precisie en betrouwbaarheid.

Door exacte centrering en minimale zichtbare onderdelen ontstaat een rustig beeld. Alle technische componenten zijn onzichtbaar geïntegreerd, waardoor vorm en functionaliteit vanzelfsprekend samenvallen.



Auckland, New Zealand

Precision and contrast

FOLD reference: private residence

Interior design: Christian Anderson Architects

Photography: Simon Devitt

Product: FOLD TB100 satin stainless steel (left, below),

FOLD TB500 satin stainless steel (next page - left),

FOLD TB20M satin stainless steel (next page - right)

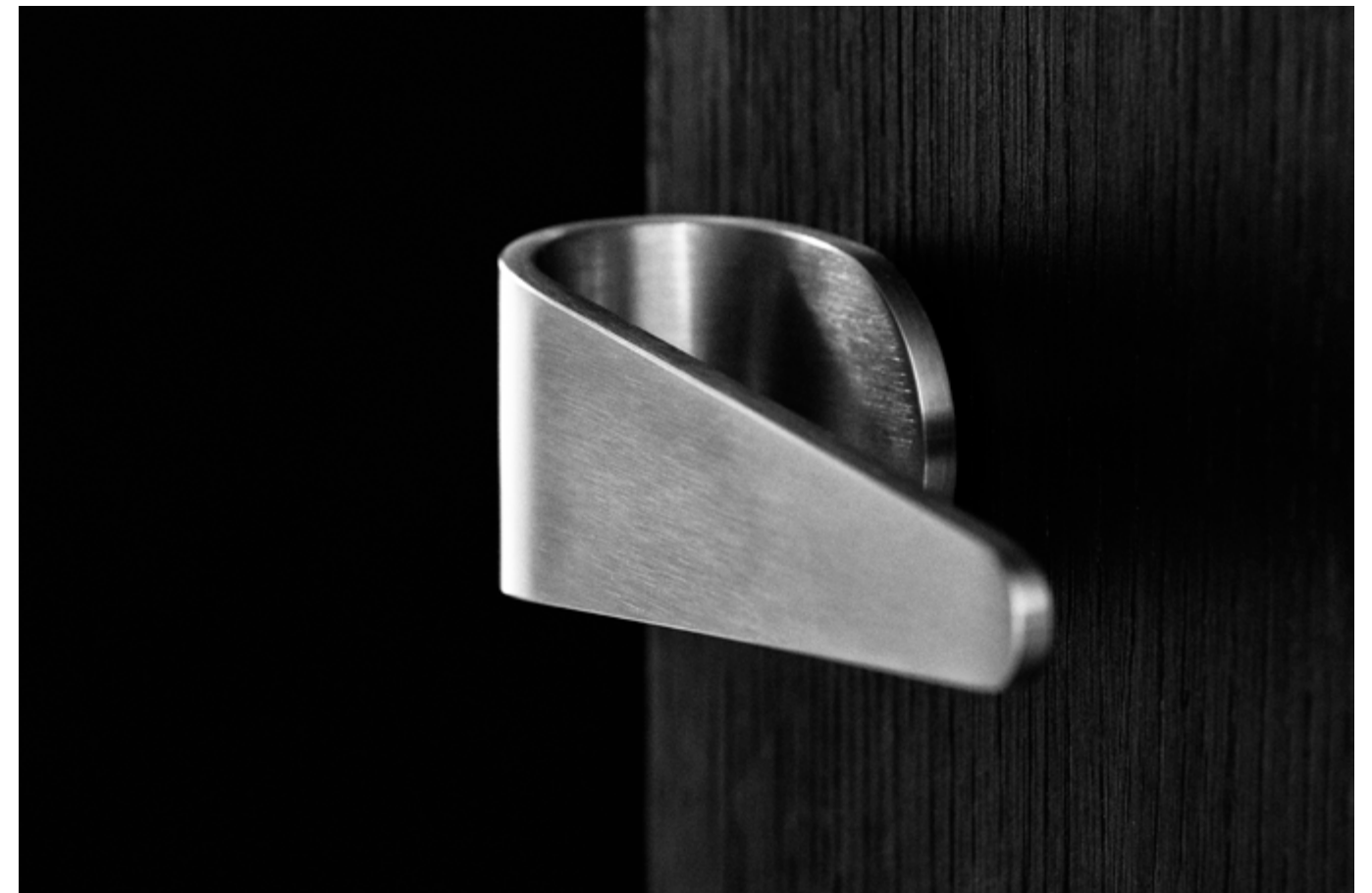



In this private residence in Auckland, Christian Anderson Architects shape minimalism through contrast and precision. Clean white planes meet dark timber surfaces, while daylight shifts highlight edges and textures, creating a calm, measured rhythm.

The FOLD collection integrates naturally within this restrained setting. Its softly bent form introduces a quiet sculptural note, supporting the interior's balance while preserving its clarity and composure.



In deze privéwoning in Auckland geeft Christian Anderson Architects vorm aan minimalisme via contrast en precisie. Strakke witte vlakken ontmoeten donker hout, terwijl daglicht randen en texturen accentueert en zo een rustig, beheerst ritme creëert.

De FOLD-collectie voegt zich moeiteloos in dit ingetogen geheel. De zacht gebogen vorm brengt een stille sculpturale nuance aan en ondersteunt de balans van het interieur, met behoud van helderheid en rust.

TB100



1

solid sprung lever handle on concealed rose
ideal backset lock 60mm

massieve deurkruk geveerd op verborgen rozet
ideale doormaat slot 60mm

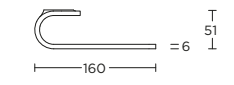
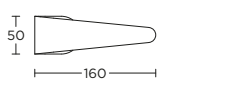



BBN53

BBY53

BBB53

TBWC50



formani.com/M001

TB200V



1

solid fixed front door knob
massieve vaste voordeurknop

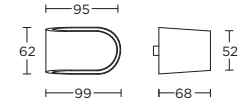

formani.com/M006

TB500



1

solid pull handle for timber, glass or aluminium doors
bolt through, concealed or back to back fixings

massieve greep tbv houten, glazen of aluminium deuren

doorgaande, niet-doorgaande of paarsgewijze bevestiging

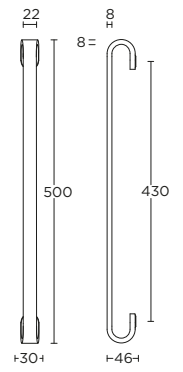

formani.com/M007

BBN53



1

key escutcheon
sleutelplaatje

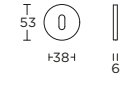

formani.com/M002

BBY53



1

profile cylinder escutcheon
cilinderplaatje

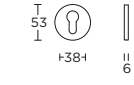

formani.com/M003

TB20/160



1

solid cabinet handle
massieve meubelgreep

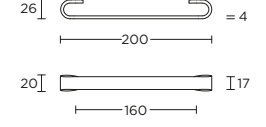

formani.com/M008

TB20/230



1

solid cabinet handle
massieve meubelgreep

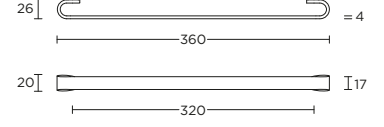

formani.com/M009

TBWC50



1

turn and release set
toiletgarnituur

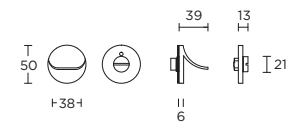

formani.com/M005

TB20M



1

solid cabinet knob
massieve meubelknop

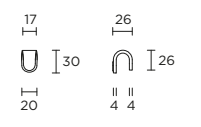

formani.com/M010

1 satin stainless steel

TB230



formani.com/M011

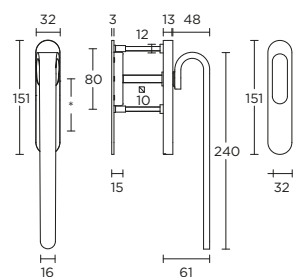

1

single solid internal lift-up sliding door handle with external flush pull

*blind or Y69

massieve set hefschuifdeurbeslag inclusief inbouwkom voor buitenzijde

*blind of PC69

more options available: pricelist or formani.com/001M

1 satin stainless steel

EM DESIGN HANDEL

Julius-Hölder-Str. 56

70597 Stuttgart

Tel. 0711-34218605

info@emdesignhandel.de

shop.emdesignhandel.de