

# ELEEZ

by Zaha Hadid Design

Obsessed with Details — 2026 Collection

# ELEEZ

by Zaha Hadid Design

# Shaped by movement, built for precision.

Harmoniously blending cutting-edge design with functional elegance, the Eleez collection by Zaha Hadid Design draws on the spiraling lines of a helix. Carved into the handle's cylindrical surface, its gentle curves convey geometric dynamism while ensuring solidity and ease of use. Each piece reflects Zaha Hadid Design's methodical approach, combining sculptural forms with ergonomic precision to turn door hardware into striking, functional elements for any interior.

Harmonisch samensmeltend met baanbrekend design en functionele elegantie, is de Eleez-collectie van Zaha Hadid Design geïnspireerd op de spiraalvormige lijnen van een helix. In het cilindrische oppervlak van de deurkruk straalt deze zachte kromming geometrische dynamiek uit, met behoud van stevigheid en gebruiksgemak. Elk onderdeel weerspiegelt Zaha Hadid Design's methodische aanpak, waarin sculpturale vormen en ergonomische precisie samenkomen tot visueel aansprekende, functionele elementen voor elk interieur.



# by Zaha Hadid Design

*“In collaboration with Formani, we combined elegant design, ergonomic solutions, and sustainable materials and processes, reflecting our shared values of innovation and environmental responsibility.”*

**London, United Kingdom**

Established in 2006 by Zaha Hadid  
(† 31.03.2016)

Design philosophy:  
Zaha Hadid Design fuses experimental innovation with rigorous methodology, translating over 40 years of research into fluid, dynamic forms across diverse scales and typologies.”

Designed for FORMANI:  
ELEEZ

Photography:  
Brigitte Lacombe



# ELEEZ

# Total concept

## Door fittings

Lever handles  
Lever handle accessories

## Window fittings

Tilt and turn window handles

## Front door fittings

Front door knobs  
Pull handles

## Accessories

Cabinet knobs  
Sliding door handles  
Flush pulls  
Sliding door locks  
Hinges  
Locks

## Deurbeslag

Deurkrukken  
Accessoires deurkrukken

## Raambeslag

Draaikiepbeslag

## Voordeurbeslag

Voordeurknoppen  
Grepes

## Accessoires

Meubelknoppen  
Hefschuifdeurbeslag  
Schuifdeurkommen  
Schuifdeursloten  
Scharnieren  
Sloten

**210**

210

210

**211**

211

**212**

212

212

**212**

212

212

213

213

213

214

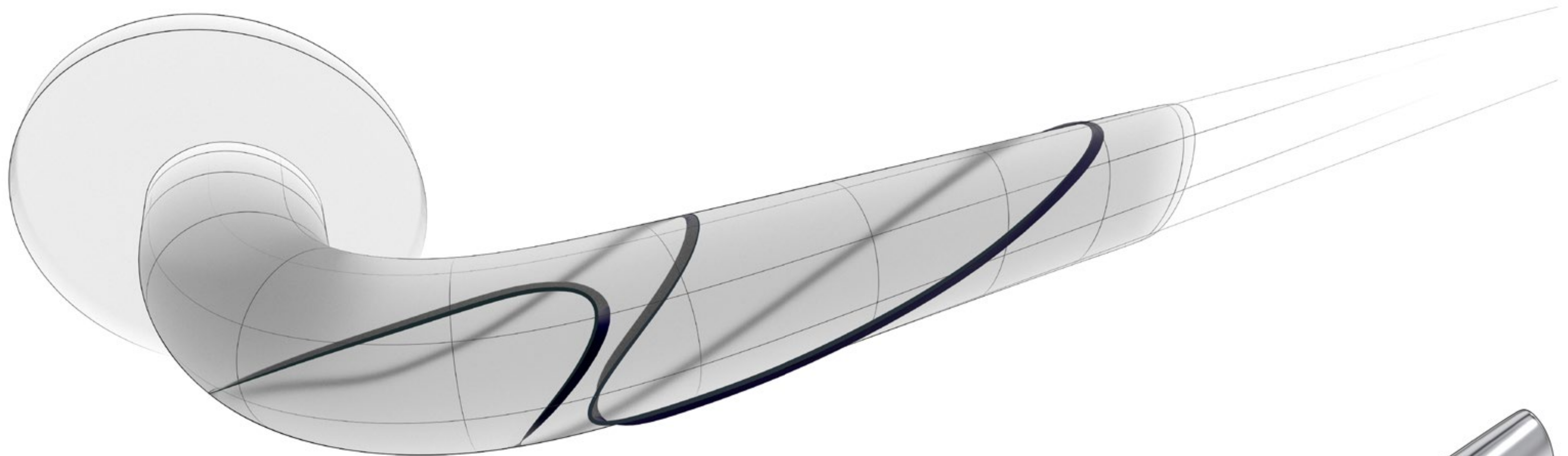

ELEEZ ZH100  
PVD light bronze





ELEEZ ZH100  
PVD champagne

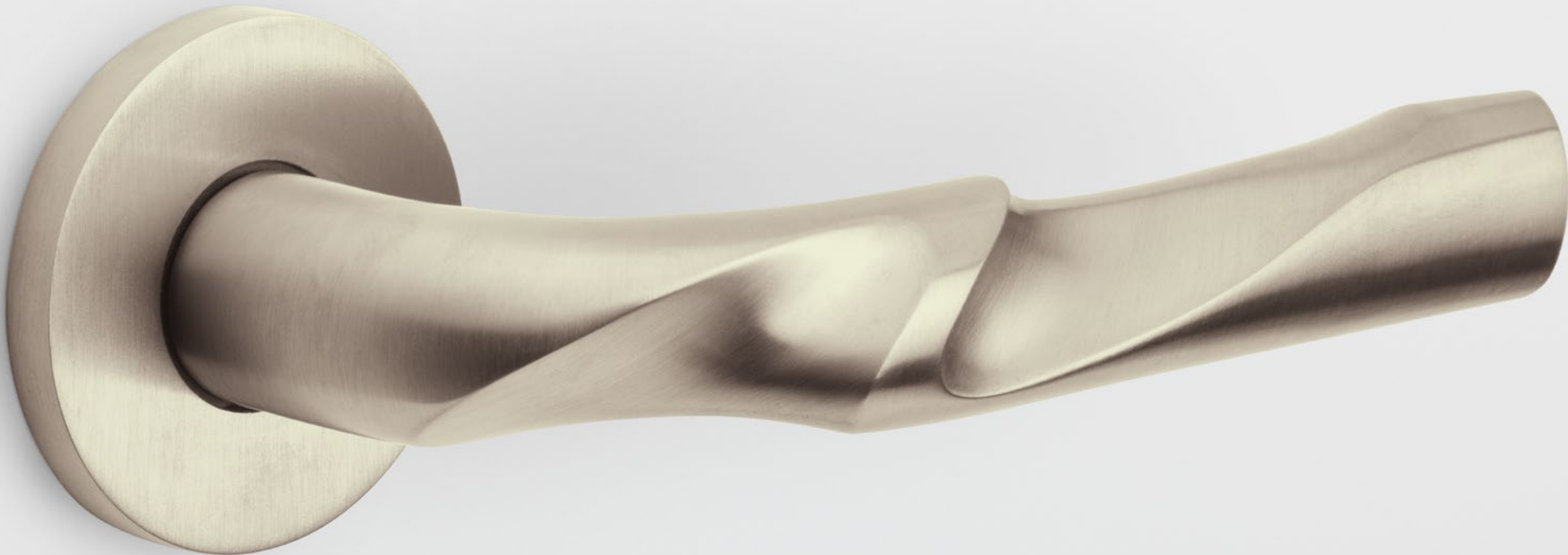



ELEEZ ZH100  
PVD satin black



ELEEZ ZH100  
PVD satin gold

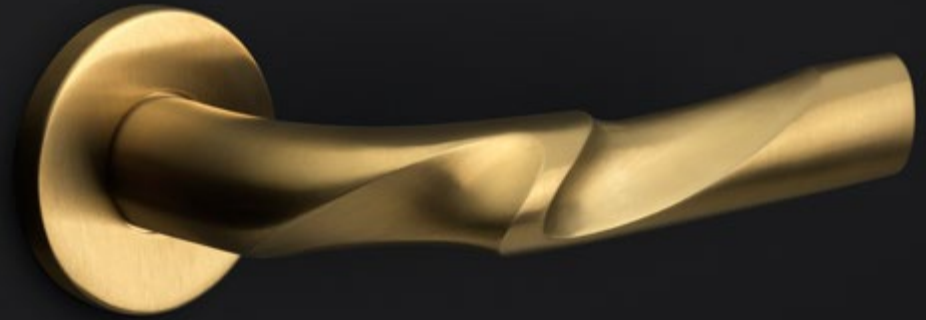

ELEEZ ZH100  
bronze



ELEEZ ZH100  
satin stainless steel



# In detail

## Micro luxury at the level of detail

In interior and architectural projects, detail plays an increasingly explicit role within the overall spatial composition. Hardware is no longer approached as a standalone element, but as part of the transition between spaces.

At this scale, micro luxury emerges when form, material and finish are consistently aligned. This precision is subtle rather than expressive, yet decisive. It introduces calm, continuity and a natural sense of cohesion.

In interieur- en architectuurprojecten speelt detail een steeds explicietere rol binnen de totale ruimtelijke samenhang. Beslag wordt daarbij niet gezien als een los element, maar als onderdeel van de overgang tussen ruimtes.

Juist op dat schaalniveau ontstaat micro-luxe, wanneer vorm, materiaal en afwerking consequent op elkaar zijn afgestemd. Deze precisie is nauwelijks opvallend, maar wel bepalend. Ze brengt rust, continuïteit en een vanzelfsprekende samenhang in het interieur.







# London, United Kingdom

## Movement and continuity

ELEEZ reference: Roca London Gallery  
Interior design: Zaha Hadid  
Photography: Hufton + Crow  
Product: ELEEZ ZH100 satin stainless steel





Designed by Zaha Hadid Architects, the Roca London Gallery expresses a fluid architectural language shaped by movement and continuity. Inspired by the dynamics of water, sculptural concrete walls, curved ceilings and organic circulation create a seamless spatial experience in which light, form and motion are closely intertwined. This architectural approach forms an important source of inspiration for ELEEZ.

Building on these principles, the helix-inspired form translates architectural thinking into a refined, tactile scale. Designed by Zaha Hadid Design for FORMANI, the stainless steel surface reinforces the interplay of light and shadow, supporting a controlled and continuous expression that brings architectural intent into everyday use.

De Roca London Gallery, ontworpen door Zaha Hadid Architects, wordt gekenmerkt door een vloeiende architectonische taal waarin beweging en continuïteit centraal staan. Geïnspireerd door de dynamiek van water zorgen sculpturale betonnen wanden, gebogen plafonds en organische circulatie voor een naadloze ruimtelijke beleving waarin licht, vorm en beweging samenkomen. Deze benadering vormt een belangrijke inspiratiebron voor ELEEZ.

Voortbouwend op deze principes vertaalt de helix-geïnspireerde vorm architectonisch denken naar een verfijnd, tactiel detail. Ontworpen door Zaha Hadid Design voor FORMANI versterkt het roestvaststalen oppervlak het samenspel van licht en schaduw en ondersteunt het een doorlopende vormtaal waarin architectonische intentie voelbaar wordt in dagelijks gebruik.





# Baku, Azerbaijan

## Flow and continuity

ELEEZ reference: Heydar Aliyev Center  
Architecture: Zaha Hadid  
Photography: Iwan Baan  
Product: ELEEZ ZH400 PVD light bronze





Designed as a continuous, flowing form, the Heydar Aliyev Centre approaches architecture as movement rather than object. Lines dissolve into one another, creating rhythm and continuity that define the building's identity. This architectural approach serves as an important source of inspiration for ELEEZ. The slender helix form builds on this way of thinking and translates architectural principles into a refined, tactile scale. Designed in collaboration with Zaha Hadid Design, ELEEZ aligns naturally with this visual language. Calm, continuous and precisely considered, it brings architectural intent into everyday interaction.

Ontworpen als één doorlopende beweging benadert het Heydar Aliyev Centre architectuur niet als object, maar als beweging. Lijnen vloeien in elkaar over en creëren een ritme en continuïteit die het karakter van het gebouw bepalen. Deze benadering vormt een belangrijke inspiratiebron voor ELEEZ.

De slanke helixvorm bouwt voort op deze manier van denken en vertaalt architectonische principes naar een verfijnd, tactiel detail. Ontworpen in samenwerking met Zaha Hadid Design sluit ELEEZ vanzelfsprekend aan bij deze visuele taal. Rustig, doorlopend en zorgvuldig uitgewerkt, wordt architectonische intentie voelbaar in het dagelijks gebruik.



## Madrid, Spain

ELEEZ reference: Hotel Puerta America  
Interior design: Zahad Hadid  
Photography: Rafael Vargas  
Product: ELEEZ ZH100 PVD satin black





# Oslo, Norway

## Quiet precision in motion

ELEEZ reference: SIXA Conference

Interior design: Studio Kaape

Photography: Martin Rustad

Product: ELEEZ ZH100 PVD light bronze

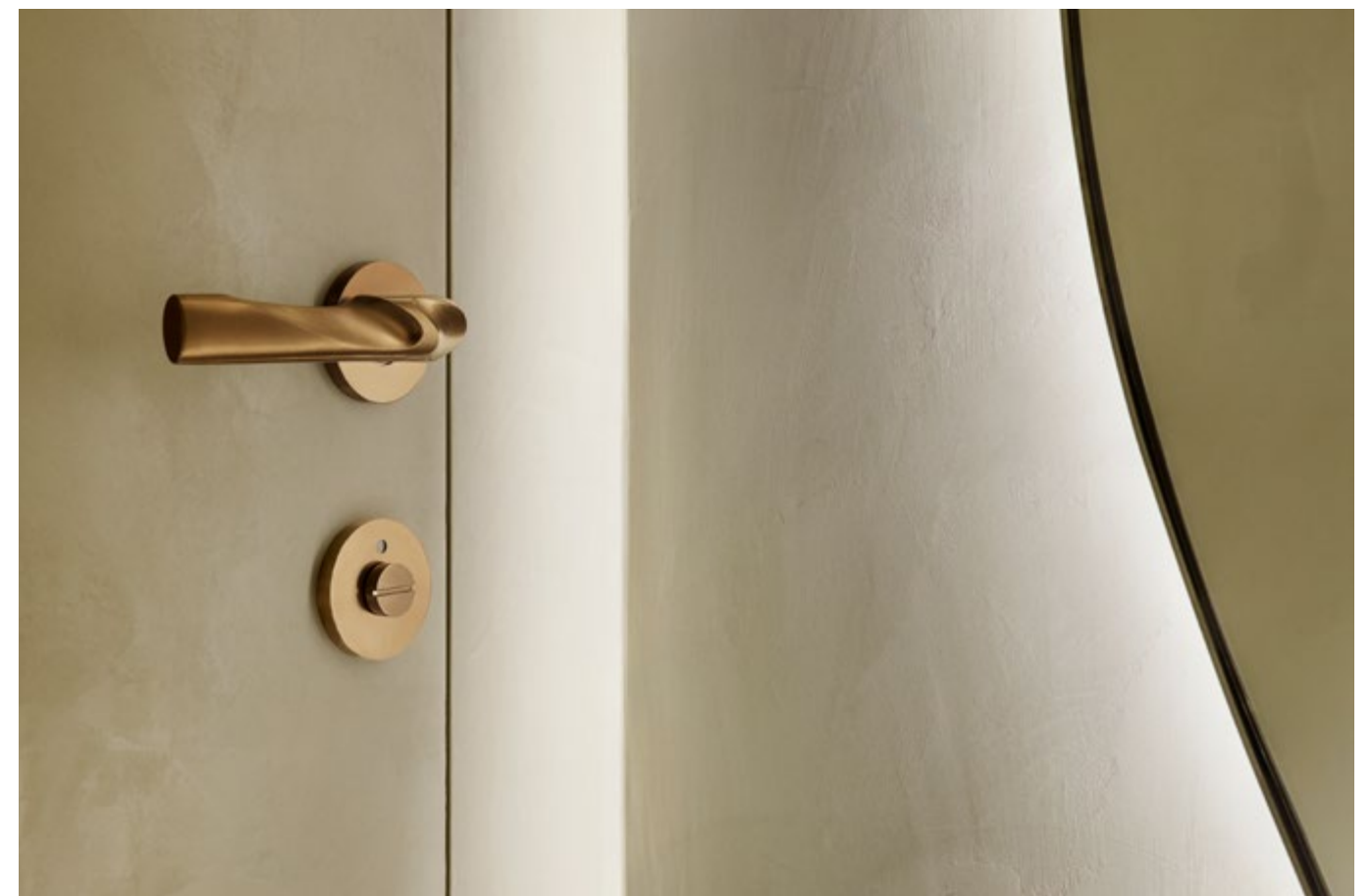

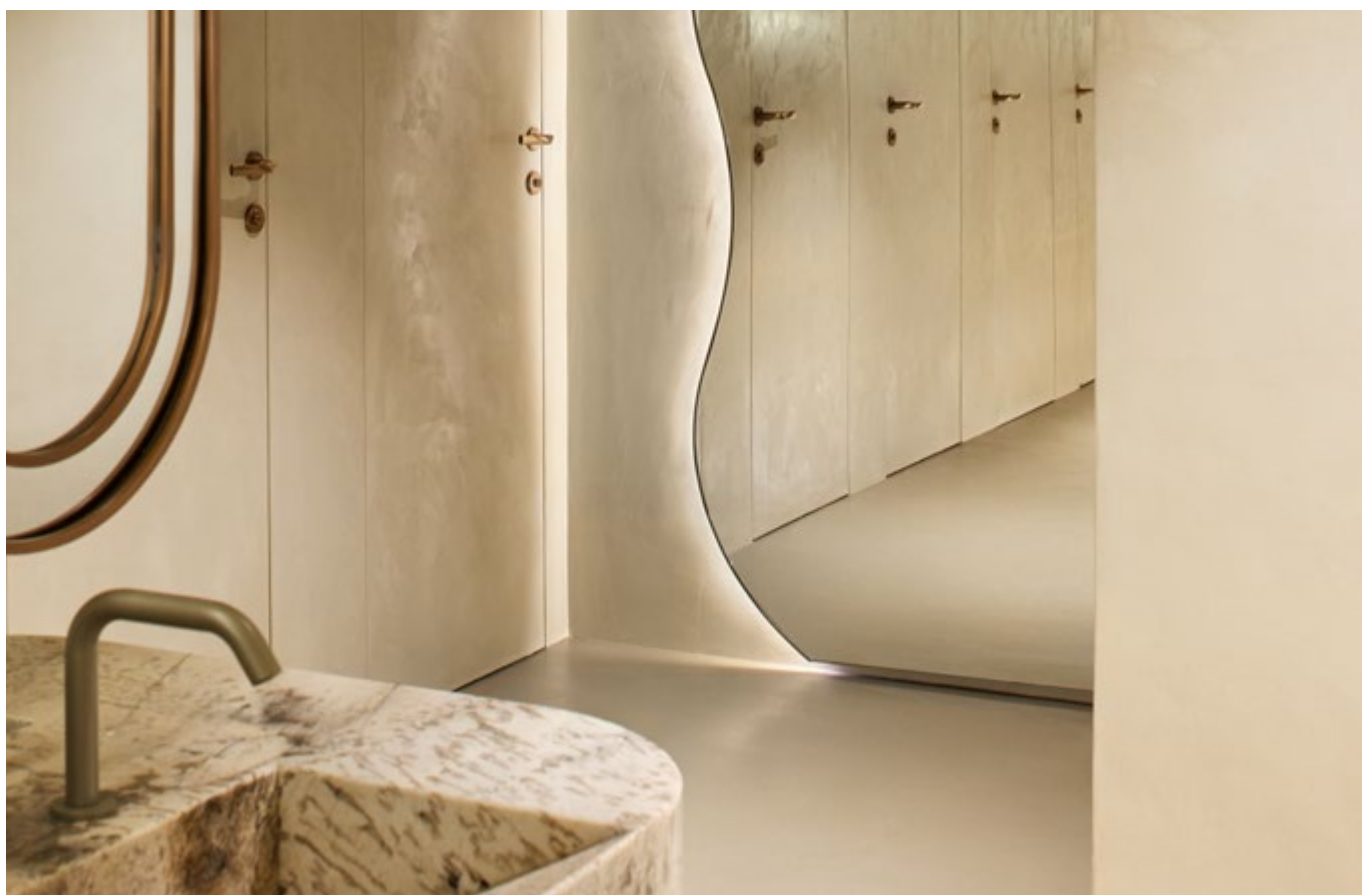

Within SIXA Conference, a setting for meetings and professional gatherings, the interior is defined by a clear spatial language and a restrained use of materials. Soft wall finishes, flowing lines and controlled lighting create a calm atmosphere that supports focus and concentration.

Subtle curves guide movement through the space, while refined plaster finishes and natural stone introduce a quiet sense of depth. Door hardware from the ELEEZ collection in PVD light bronze integrates naturally within this material palette. The warm metallic tone adds nuance without contrast, supporting the overall harmony of the interior.

Binnen SIXA Conference, een omgeving voor vergaderingen en professionele bijeenkomsten, wordt het interieur gekenmerkt door een heldere ruimtelijke opzet en een ingetogen materiaalgebruik. Zachte wandafwerkingen, vloeiende lijnen en zorgvuldig gedoseerd licht zorgen voor een rustige sfeer die focus en concentratie ondersteunt.

Subtiële rondingen begeleiden de beweging door de ruimte, terwijl verfijnde pleisterafwerkingen en natuursteen een stille gelaagdheid toevoegen. Het deurbeslag uit de ELEEZ-collectie in PVD licht brons voegt zich vanzelfsprekend in dit materiaalpalet. De warme metaaltoon brengt nuance, zonder contrast te zoeken, en ondersteunt de harmonie van het interieur.



**ZH100**



1 5 7  
10 16 17

solid sprung or unsprung lever handle attached to rose with metal sub-rose

massieve deurkruk vast-draaibaar geveerd of ongeveerd op rozet met metalen onderconstructie

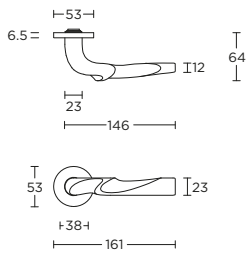

0 ZHN53  
1 ZHY53  
2 ZHB53  
3 ZHWC53

formani.com/S001

**ZH100-DK-O**



1 5 7  
10 16 17

non-locking tilt and turn window handle

draaikiepgarnituur niet afsluitbaar

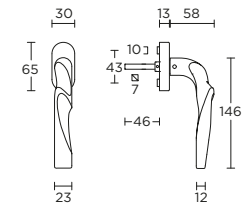

formani.com/S006

**ZH100-DKLOCK-O**



1 5 7  
10 16 17

locking tilt and turn window handle

draaikiepgarnituur afsluitbaar

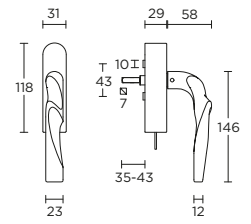

formani.com/S007

**ZHN53**



1 5 7  
10 16 17

key escutcheon

sleutelplaatje

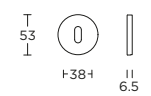

formani.com/S002

**ZHY53**



1 5 7  
10 16 17

profile cylinder escutcheon

cilinderplaatje



formani.com/S003

**ZHWC53**



1 5 7  
10 16 17

turn and release set, also available without white/red indicator

toiletgarnituur, ook zonder wit/rood indicator beschikbaar



formani.com/S005

- 1 satin stainless steel
- 5 PVD satin black
- 7 bronze
- 10 PVD satin gold
- 16 PVD light bronze
- 17 PVD champagne

**ZH200V**



1 5 7  
10 16 17

solid front door knob  
massieve voordeurknop



52  
38  
60

formani.com/S008

**ZH400-R**



1 5 7  
10 16 17

solid pull handle for timber, glass or aluminium doors  
bolt-through, concealed or back to back fixings  
massieve greep tbv houten, glazen of aluminium deuren  
doorgaande, niet-doorgaande of paarsgewijze bevestiging

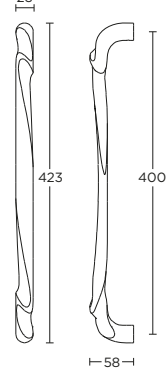

23  
423  
400  
58

formani.com/S010

**LB57S**



1 5 7  
10 16 17

set of flush pulls for glue fixing including spindle (lock available separately)  
set inbouwkommen te verlijmen inclusief stift (slot apart verkrijgbaar)



20 22 2  
48 6  
44 57  
H

formani.com/P102

**LB57**



1 5 7  
10 16 17

flush pull for glue fixing  
inbouwkom te verlijmen

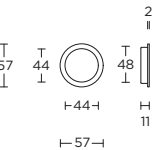

2  
57 44 48  
44  
H  
57

formani.com/P103

**ZH400-L**



1 5 7  
10 16 17

solid pull handle for timber, glass or aluminium doors  
bolt-through, concealed or back to back fixings  
massieve greep tbv houten, glazen of aluminium deuren  
doorgaande, niet-doorgaande of paarsgewijze bevestiging

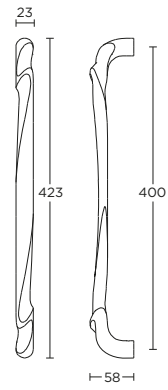

23  
423  
400  
58

formani.com/S010

**ZH25M**



1 5 7  
10 16 17

solid cabinet knob  
massieve meubelknop

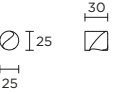

25 30  
25

formani.com/S009

**LB29**



1 5 7  
10 16 17

fingertip edge fitting for glue fixing  
fingertip kopse kant deur te verlijmen

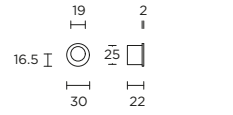

19 2  
16.5 25  
30 22

formani.com/P104

**LBLSDA**



1 6 7  
10 16 17

rounded sliding door lock, 50 mm backset  
afgerond schuifdeurslot, doorsmaat 50 mm



50  
158 6  
70 100  
30  
38  
88  
18

formani.com/Q129

**ZH230**



1 5 7  
10 16 17

solid internal lift-up sliding door handle with external flush pull  
\*blind or Y69  
massieve set hefschuifdeurbeslag inclusief inbouwkom voor buitenzijde  
\*blind of PC69  
more options available: pricelist or formani.com/001S

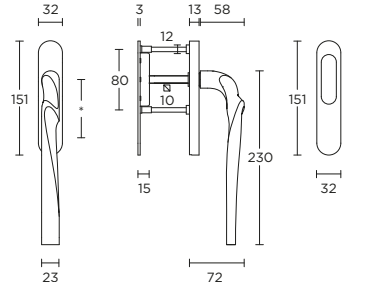

32 3 13 58  
151 80 12 10 151 230  
23 15 72 32

formani.com/S011

**LBSA8989**



1 6 7  
10 16 17

hinge with ball bearings  
kogellagerscharnier  
more options available: pricelist or formani.com/003D

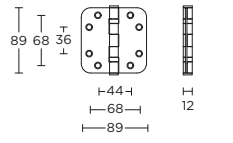

2.4  
89 68 36  
44 68 89  
H 12

formani.com/Q122

**LBS3D140**



1 6 7  
10 16 17

3D hinge  
3D scharnier



25 31  
18-20  
1301 1301 140 101 117.5

formani.com/Q130

- 1 satin stainless steel
- 5 PVD satin black
- 6 PVD gunmetal
- 7 bronze
- 10 PVD satin gold
- 16 PVD light bronze
- 17 PVD champagne

LBLA60-SFC



formani.com/Q131

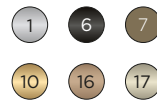
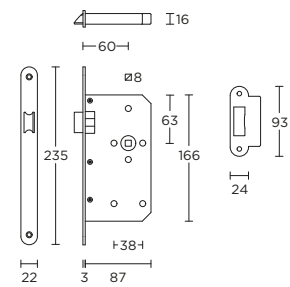

rounded passage lock case including oval strike plate in satin stainless steel, 60 mm backset

afgerond loopdeurslot inclusief ovale sluitplaat in mat roestvast staal, doorsmaat 60 mm

more options for locks and strike plates available: **BASICS** chapter, pricelist or [formani.com/006Q](http://formani.com/006Q)

LBLA-SFC



formani.com/Q134

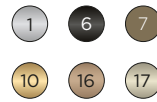
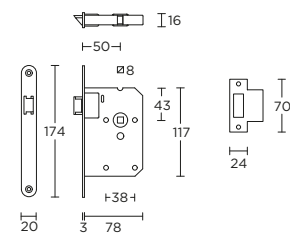

rounded passage lock case including rectangular strike plate in satin stainless steel, 50 mm backset

afgerond loopdeurslot inclusief rechthoekige sluitplaat in mat roestvast staal, doorsmaat 50 mm

more options for locks and strike plates available: **BASICS** chapter, pricelist or [formani.com/006Q](http://formani.com/006Q)



# EM DESIGN HANDEL

---

Julius-Hölder-Str. 56

70597 Stuttgart

Tel. 0711-34218605

[info@emdesignhandel.de](mailto:info@emdesignhandel.de)

[shop.emdesignhandel.de](http://shop.emdesignhandel.de)